

TRACK CATALOG

	PAGE(S)
Running Track Surfaces	2
Running Track Rubber Curbing	3-5
Running Track Aluminum Curbing & Roll Out Runway	6
Multiple Lane Dry Line Chalker / Marking Chalk.....	7
Running Track Protective Covers	8-13
Hurdles	14-17
Starting Blocks	18-20
Long Jump & High Jump Pit Surfaces	21-22
Long Jump Pit Covers	23-24
Take-Offs & Toe Boards	25
High Jump	26-32
Pole Vault	33-40
Shot Put Throwing Sector Surfaces	41
Shots Throwing Weights Hammers	38, 42-43
Stands, Wagons, Rakes	44
Officiating.....	45
Discus Cage, Rings, Sector Guide, Tape	46-47



YOUR "ONE-STOP" SOURCE FOR AMERICA'S BASEBALL, SOFTBALL & SPORTS SURFACES & SUPPLIES!

PRICES SUBJECT TO CHANGE & AVAILABILITY PLUS SHIPPING | VOLUME DISCOUNTS AVAILABLE | COOPERATIVE PURCHASING CONTRACT PRICING FOR 50 STATES

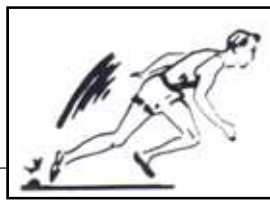

JET TRACK™ RUNNING TRACKS

Economical Alternatives to Synthetic, All-Weather Tracks for New Running Tracks or for Many Years Of Higher Performance from Your Existing Cinder Track!

Jet Track Mixes, which can be applied over your present cinder track, are quality controlled mixes, with natural clay or Stabilizer® Binder blended with 3/16" crushed aggregate, superior to coal cinders as they will not break down and become powdery.

Jet Track Mix makes a firm, smooth surface with great drainage. Available in burgundy red, grey, black, white or tan, with either 20% red, grey, black, white or tan **Beam Clay® Binder** for a smoother surface, or 5% red, grey, black, white or tan **Beam Clay® Binder** for a somewhat "crunchier" surface, or **"STABILIZED"** in red, grey, black, white or tan for a firmer, yet more resilient, surface – each with excellent drainage and resistance to erosion. Excellent natural surfaces for walking paths & jogging trails. Easy to maintain: Recommended maintenance is to scarify and roll each spring. Otherwise, drag mat as needed to maintain smooth surface. Recommended depth for a new track is 3"; for resurfacing a cinder track 1-3". Resurfacing a cinder track can be tapered with 3" on inside lanes out to 1" in outer lanes.

Stabilizer® binds the aggregate together for a firm, yet more resilient, natural running track surface requiring minimal maintenance.

3/16" Red, Grey, Black, White or Tan Jet Track™ with Natural Beam Clay® Binder

One cubic yard weighs approximately 2,700 lbs. in red, approximately 3,240 lbs. in grey, black white or tan, plus add 20% for compaction. Each 1" compacted requires approximately 5 tons per 1,000 square feet for red, 6 tons for grey, black, white or tan. Each 1" compacted over a 400 meter x 32' wide running track with starting area will require approximately 248 tons for red, 298 tons for grey, black, white or tan.

		BULK/TON		50 LB. BAG Up to 50/pallet
Burgundy Red with 5% Beam Clay® Red Binder	JT-R5 BULK	\$79	JT-R5 BAG	\$9
Burgundy Red with 20% Beam Clay® Red Binder	JT-R20 BULK	\$109	JT-R20-BAG	\$10
Grey with 5% Beam Clay® Grey Binder	JT-G5-BULK	\$69	JT-G5 BAG	\$8.75
Grey with 20% Beam Clay® Grey Binder	JT-G20-BULK	\$99	JT-G20 BAG	\$9.50
Black or White with 5% Beam Clay® Black or White Binder	JT-(B, W)5-BULK	\$79	JT-(B, W)5 BAG	\$9.00
Black or White with 20% Beam Clay® Black or White Binder	JT-(B, W)20-BULK	\$109	JT-(B, W)20 BAG	\$10
Tan with 5% Beam Clay® Tan Binder	JT-T5 BULK	\$145	JT-T5 BAG	\$12
Tan with 20% Beam Clay® Tan Binder	JT-T20 BULK	\$175	JT-T20 BAG	\$13



3/16" Red, Grey, Black, White or Tan Stabilized Jet Track™ with Stabilizer® Binder

For an even firmer yet more resilient surface with even less maintenance: 3/16" crushed aggregate blended with Stabilizer® at the rate of 15 lbs. per ton of aggregate. One cubic yard weighs approximately 2,700 lbs. in red, approximately 3,240 lbs. in grey, black, white or tan plus add 20% for compaction. Each 1" compacted requires approximately 5 tons per 1,000 square feet for red, 6 tons for grey, black, white or tan. Each 1" compacted over a 400 meter x 32' wide running track with starting area will require approximately 248 tons for red, 298 tons for grey, black, white or tan.

		BULK/TON		50 LB. BAG Up to 50/pallet
Burgundy Red with Stabilizer® Binder	JT-RS BULK	\$135	JT-RS BAG	\$11.25
Grey with Stabilizer® Binder	JT-GS BULK	\$125	JT-GS BAG	\$11
Black or White with Stabilizer® Binder	JT-(B,W)S BULK	\$135	JT-(B,W)S BAG	\$11.25
Tan with Stabilizer® Binder	JT-TS BULK	\$205	JT-TS BAG	\$13.50

We have other Clay track surfaces without **BEAM CLAY®** binder or **STABILIZER®** binder. While these will not give the level of performance as the above for running tracks, they do provide excellent surfaces for walking or jogging tracks:

Regional CRUSHED RED STONE TRACK MIXES, RED BRICK TRACK, and RED LAVA TRACK from plants in the East, South, MidWest, and West Coast.

PALLET & COVER CHARGES: \$10.50/PALLET. #NJ-PALLET

YOUR "ONE-STOP" SOURCE FOR AMERICA'S BASEBALL, SOFTBALL & SPORTS SURFACES & SUPPLIES!

PRICES SUBJECT TO CHANGE & AVAILABILITY PLUS SHIPPING | VOLUME DISCOUNTS AVAILABLE | COOPERATIVE PURCHASING CONTRACT PRICING FOR 50 STATES

RUNNING TRACK RUBBER CURBING

PER PIECE

4" High x 4" Wide x 6' Long (30 lbs./piece, up to 99 pieces/pallet)	#RC-4X4X6	\$45
6" High x 4" Wide x 6' Long (45 lbs./piece, up to 63 pieces/pallet)	#RC-6X4X6	\$77
8" High x 4" Wide x 6' Long (70 lbs./piece, up to 45 pieces/pallet)	#RC-8X4X6	\$110
4" High x 3" Wide x 4' Long (13 lbs./piece, up to 140 pieces/pallet)	#RC-4X3X4	\$28

*Please note: The 4" wide sections are grooved and can be stacked to create desired height,. However, the 3" W is not stackable. 3" W lengths of curbing are **not grooved for stacking.***

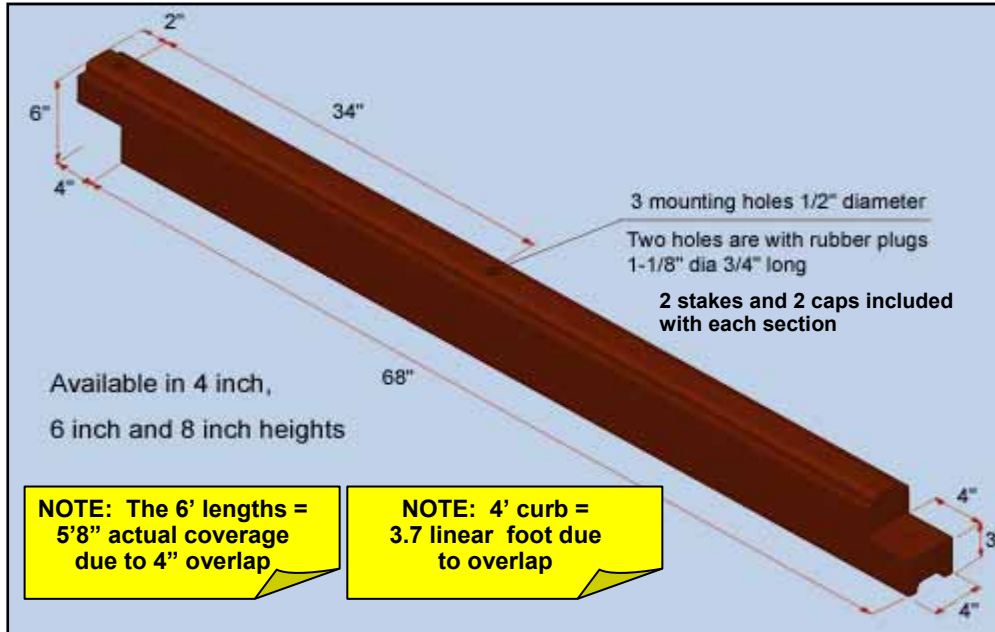

NOTE: The 6' lengths = 5'8" actual coverage due to 4" overlap

NOTE: 4' curb = 3.7 linear foot due to overlap

- \$ More resilient than wood
- \$ No warping or discoloring
- \$ No splinters
- \$ Non toxic
- \$ Will not rot
- \$ Stackable
- \$ Interlocking
- \$ Available in 4 ft lengths and 4" High or 6 ft lengths in 4", 6" and 8" heights
- \$ No CCA or other harmful chemicals
- \$ Easy to install with pre drilled holes
- \$ Made from 100% recycled tires
- \$ Flexible with rounded edges
- \$ Will not breed ticks, termites or other insects
- \$ Maintenance free
- \$ Hardware & Caps included
- \$ Neutral brown tone-compatible with any surface color

2 stakes and 2 caps are included with each curb

natural brown
bendable
stackable
interlocking
hardware included

YOUR "ONE-STOP" SOURCE FOR AMERICA'S BASEBALL, SOFTBALL & SPORTS SURFACES & SUPPLIES!

PRICES SUBJECT TO CHANGE & AVAILABILITY PLUS SHIPPING | VOLUME DISCOUNTS AVAILABLE | COOPERATIVE PURCHASING CONTRACT PRICING FOR 50 STATES

RUNNING TRACKS - INSTALLING RUBBER CURBING



YOUR " ONE-STOP " SOURCE FOR AMERICA'S BASEBALL, SOFTBALL & SPORTS SURFACES & SUPPLIES!

PRICES SUBJECT TO CHANGE & AVAILABILITY PLUS SHIPPING | VOLUME DISCOUNTS AVAILABLE | COOPERATIVE PURCHASING CONTRACT PRICING FOR 50 STATES

Rubber Curbing For Running Tracks

Product Specifications

Product Description:

1. Material: compression molded composite of the 100% recycled rubber and polyurethane prepolymer
2. Physical properties of the rubber composite:
 - a) Density 0.6 oz/cu in (ASTM C642)
 - b) Durometer Hardness 65A \pm 7 (ASTM D2240)
 - c) Tensile Strength* minimum 125 psi (ASTM D412)
(* main structural areas)
 - d) Compression deformation 10% at 70psi, 68°F (ASTM D575)
 - e) Brittleness at Low temperature: -40°F (ASTM D746)
 - f) Freeze and thaw when exposed (ASTM C672)
to deicing chemicals no loss after 50 cycles
 - g) Coefficient of thermal expansion: 8 x10⁻⁵ in/in/°F (ASTM C531)
 - h) Weathering 70 hours at 158°F (ASTM D573)
 - hardness retained 100% (\pm 5%)
 - compressive strength 100% (\pm 5%)
 - tensile strength 100% (\pm 5%)
 - elongation retained 100% (\pm 5%)
3. Available models:
 - a) 4"W x 4"H x 72"L with weight of 30 lbs.
 - b) 4"W x 6"H x 72"L with weight of 45 lbs.
 - c) 4"W x 8"H x 72"L with weight of 70 lbs.
 - d) 3"W x 4"H x 72"L with weight of 20 lbs.
 - e) 3"W x 4"H x 48"L with weight of 13 lbs.
4. Finishing color: dark brown

Installation methods:

- a) with 2 spikes 18" long x 3/8" diameter provided for each 4" high piece
- b) with 2 spikes 24" long x 3/8" diameter provided for each 6" high or 8" high piece

Note: The mounting holes can be closed after installation with the rubber plugs 1-1/8 diameter and 3/4" long, supplied with the product.

Components:

- a) 100% recycled rubber from car and truck tires (NR, SBR)
- b) polyurethane prepolymer for rubber granules
- c) brown pigment

YOUR "ONE-STOP" SOURCE FOR AMERICA'S BASEBALL, SOFTBALL & SPORTS SURFACES & SUPPLIES!

PRICES SUBJECT TO CHANGE & AVAILABILITY PLUS SHIPPING | VOLUME DISCOUNTS AVAILABLE | COOPERATIVE PURCHASING CONTRACT PRICING FOR 50 STATES

Outdoor Track Aluminum Curbing

All Weather Track Aluminum Curbing

Aluminum track curbing is designed to save tremendous amounts of labor on installation, last for decades and provide continual functionality. Accurate measurements on-site or drawings required.

- \$ Structural aluminum tubing is pre-bent to reduce stress on track surface
- \$ Installation only requires from 12 to 24 holes in your track surface, while other systems require literally hundreds of holes to be drilled to keep curb sections in place under tension
- \$ Interlocking joints between 20' sections are precision machined for a snug fit requiring no hardware connectors - allows expansion and contraction for stability under all conditions
- \$ Welded aluminum drain pads raise curb 1/2" off the track surface and allow water and debris to run off freely
- \$ Mill finish is standard or upgrade to the silver anodized finish for extra durability



Aluminum Curbing
Silver Anodized Option

#3AC
#3AC-SA

\$21.95/LF
\$28/LF



Running Track Aluminum Curbing

- \$ Outdoor track curbing composed of structural aluminum 2" x 5" tubing. Pre-bent to proper radius in 20' sections.
- \$ Designed to anchor to poured concrete monuments
- \$ Also can be used as shot-put area border

Aluminum Curbing

#5AC

\$31/LF

Roll Out Runway

- \$ Made to be rolled over existing worn out runways.
- \$ Use as a protective surface on all-weather track during football games or other activities.
- \$ Made with a black rubber/urethane mix.
- \$ 10mm (3/8") thick.
- \$ Custom lengths are available.
- \$ Minimum order 50'.
- \$ 12mm available - call for pricing

48" wide (per linear ft)

TR48

\$16.50/LF



YOUR "ONE-STOP" SOURCE FOR AMERICA'S BASEBALL, SOFTBALL & SPORTS SURFACES & SUPPLIES!

PRICES SUBJECT TO CHANGE & AVAILABILITY PLUS SHIPPING | VOLUME DISCOUNTS AVAILABLE | COOPERATIVE PURCHASING CONTRACT PRICING FOR 50 STATES



Multiple Lane Dry Chalk Track Marker

Makes preparation for a meet a quick job! Two people can lay out a track in 30 minutes. Works on any track. When a curb is present every line will be uniformly accurate to the fraction of an inch. Set-up time for use or storage is five minutes. Each hopper can hold up to 25 lbs. and go 440 yards. Hoppers do not have a shut off, it's free flowing once it starts moving, just adjust speed to obtain desired thickness.

LMLD-440-8	7 hopper 8 lane; '440 yd. capacity; class 65; 192 lbs.	Call for Price & Availability
LMLD-440-7	6 hopper 7 lane; '440 yd. capacity; class 65; 177 lbs.	Call for Price & Availability
LMLD-440-6	5 hopper 6 lane; '440 yd. capacity; class 65; 162 lbs.	Call for Price & Availability
LMLD-440-5	4 hopper 5 lane; '440 yd. capacity; class 65; 147 lbs.	Call for Price & Availability
LMLD-440-4	3 hopper 4 lane; '440 yd. capacity; class 65; 132 lbs.	Call for Price & Availability
LMLD-440-EXT	replacement hopper; '440 yd. capacity; UPS 15 lbs.	Call for Price & Availability
LMLD-MAIN	replacement main assembly, 87 lbs.	Call for Price & Availability

For full line of Athletic Field Marking Chalk see:
107A - Field Marking Chalk and Dry Line Marking Equipment

YOUR "ONE-STOP" SOURCE FOR AMERICA'S BASEBALL, SOFTBALL & SPORTS SURFACES & SUPPLIES!

PRICES SUBJECT TO CHANGE & AVAILABILITY PLUS SHIPPING | VOLUME DISCOUNTS AVAILABLE | COOPERATIVE PURCHASING CONTRACT PRICING FOR 50 STATES

BLANKET STYLE WEIGHTED TRACK PROTECTORS

TRACK PROTECTORS TAKE THE BEATING IN HIGH-TRAFFIC AREAS, so your track can stay smooth. Steel chain sewn into hem to keep wind from getting underneath.



Blanket Style Track Protector Specifications

- Fabric** Non-woven polypropylene 15 oz/sy
- Top Surface** Heat tempered, retains durability, even from cleats
- Bottom Surface** Heat tempered - loose fibers won't cling to track
- Blanket Color** Heather gray to reflect heat
- Binding Color** 18 oz. Solid Vinyl available in 14 colors, see chart
- Binding** Hemmed, weighted vinyl lies flat and stays in place



<u>15 OZ. SIZE</u>	<u>ITEM #</u>	<u>EACH</u>
7' x 30'	NWTRACK7X30	\$585
7' x 40'	NWTRACK7X40	\$685
7' x 50'	NWTRACK7X50	\$775
14' x 30'	NWTRACK14X30	\$775
14' x 40'	NWTRACK14X40	\$915
14' x 50'	NWTRACK14X50	\$1,095
14' x 75'	NWTRACK14X75	\$1,550
14' x 100**	NWTRACK14X100	\$1,950
14' x 125**	NWTRACK14X125	\$2,450
14' x 150**	NWTRACK14X150	\$2,950

CUSTOM SIZE NWTRACKCUSTOM Call for quote.

*Easier handling if made in two sections with Velcro attachment.

Printing not available on blanket-style protectors.

18 oz. Solid Vinyl Hem Colors (actual colors may vary)



YOUR "ONE-STOP" SOURCE FOR AMERICA'S BASEBALL, SOFTBALL & SPORTS SURFACES & SUPPLIES!

PRICES SUBJECT TO CHANGE & AVAILABILITY PLUS SHIPPING | VOLUME DISCOUNTS AVAILABLE | COOPERATIVE PURCHASING CONTRACT PRICING FOR 50 STATES

ARMOR MESH WEIGHTED TRACK PROTECTORS

TRACK PROTECTORS TAKE THE BEATING IN HIGH-TRAFFIC AREAS, so your track can stay smooth. Steel chain sewn into hem to keep wind from getting underneath

- \$ Heavy-duty 14 OZ. vinyl coated woven mesh polyester
- \$ allows water to drain thru.
- \$ Available in 13 colors

<u>14 OZ. SIZE</u>	<u>ITEM #</u>	<u>EACH</u>
6' x 30'	AMTRACK6X30	\$535
6' x 40'	AMTRACK6X40	\$635
6' x 50'	AMTRACK6X50	\$745
12' x 30'	AMTRACK12X30	\$695
12' x 40'	AMTRACK12X40	\$935
12' x 50'	AMTRACK12X50	\$1,150
15' x 30'	AMTRACK15X30	\$815
15' x 40'	AMTRACK15X40	\$1,065
15' x 50'	AMTRACK15X50	\$1,325
15' x 75'	AMTRACK15X75	\$1,895
15' x 100'	AMTRACK15X100	\$2,450
30' x 50'	AMTRACK30X50	\$2,295
Custom Size	AMTRACKCUST	\$1.98/SF

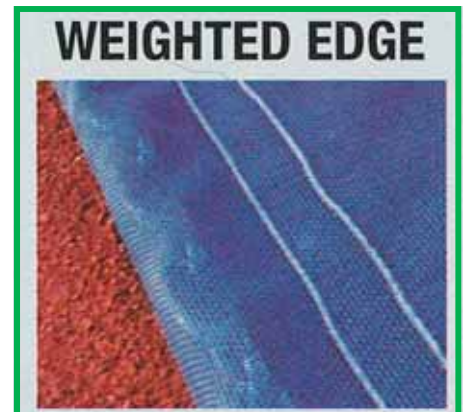

Please note: Armor Mesh Weighted Track Protectors are manufactured without solid vinyl edging. If solid vinyl edging is required add 10%.

LETTERING/ONE OR MULTI-COLORED

12"H	LETTER12	\$32
14"H	LETTER14	\$34
18"H	LETTER18	\$40
24"H	LETTER 24	\$45
30"H	LETTER30	\$54
36"H	LETTER36	\$62
42" H	LETTER42	\$74
48" H	LETTER48	\$85
54" H	LETTER54	\$99
60" H	LETTER60	\$114
72"H	LETTER72	\$130
84"H	LETTER84	\$145
Minimum	LETTERMC	\$295



CUSTOM LOGOS/ONE OR MULTI-

Up to 15 SF (ex. 3' x 5')	LOGO15	\$295
Up to 30 SF (ex. 5' x 6')	LOGO30	\$395
Up to 50 SF (ex. 5' x 10')	LOGO50	\$565
Up to 100 SF (ex. 10' x 10')	LOGO100	\$995

YOUR "ONE-STOP" SOURCE FOR AMERICA'S BASEBALL, SOFTBALL & SPORTS SURFACES & SUPPLIES!

PRICES SUBJECT TO CHANGE & AVAILABILITY PLUS SHIPPING | VOLUME DISCOUNTS AVAILABLE | COOPERATIVE PURCHASING CONTRACT PRICING FOR 50 STATES

BENCH ZONE® SIDELINE TRACK PROTECTOR

WIND WEIGHTED TRACK PROTECTOR

RESISTS & CUSHIONS AGAINST CLEATS, BUT RAIN DRAINS THROUGH.

These track protectors resist and cushion against cleats, shoes, and wheeled equipment ... yet allow water to drain through. Made of tough polypropylene geotextile fabric with vinyl edging with steel chain inserted all around for ballast. This keeps Protector down even in high winds without stakes. To reduce weight for easier installation, longer Sideline models have sections that join with hook-and-loop strips. Tarp body is black. Standard edging is choice of white or gold. Also available: 15 other colors of the 18 oz. vinyl edging.



BZST1550	15' X 50'		\$1,100
BZST1575	15' x 75'	284 lbs.	\$1,395
BZST15100	15' x 100'***	352 lbs.	\$1,775
BZST15125	15' x 125'***	420 lbs.	\$2,025
BZST15150	15' x 150'***	488 lbs.	\$2,250
BZSTX	CUSTOM SIZES, OVER 801 SF		\$1.20/SF

** UNITS ARE IN TWO PIECES THAT JOIN AT CENTERLINE WITH VELCRO® FASTENING

18 OZ. VINYL COLOR CHART

White	Grey	Beige/Tan	Black	Maroon	Red	Orange	Yellow/Gold	
Kelly Green	Midnight Green	Medium Green	Navy	Royal Blue	CC Sky Blue	Purple	Vegas Gold	Sport Grey/Charcoal

ACTUAL COLOR OF MATERIALS MAY VARY FROM EACH "LOT" / "RUN".

IF YOU ARE TRYING TO MATCH A SPECIFIC COLOR, PLEASE REQUEST A SAMPLE FROM THE CURRENT STOCK AVAILABLE FOR PRODUCTION.

YOUR "ONE-STOP" SOURCE FOR AMERICA'S BASEBALL, SOFTBALL & SPORTS SURFACES & SUPPLIES!

PRICES SUBJECT TO CHANGE & AVAILABILITY PLUS SHIPPING | VOLUME DISCOUNTS AVAILABLE | COOPERATIVE PURCHASING CONTRACT PRICING FOR 50 STATES

BENCH ZONE #3 TRACK PROTECTORS
Third Generation (3G) for Unmatched Durability, Color Choice and Imprinting

3G infuses a durable three-dimensional continuous nylon filament (Enka Mat) with our **VIPOL®** Matrix Mesh providing better cushion that **WON'T STICK TO THE TRACK**. It's **NEXT LEVEL** in all-surface protection! Add Chroma-Bond multi-color imprinting to proudly display school colors, ID and LOGO.

\$ Does Not Retain Water	3GCO630	6' X 30'	\$695/EA
\$ Is Mold and Mildew Resistant	3GCO640	6' X 40'	\$895/EA
\$ Less Expensive Than Our 2G Track Protector!	3GCO650	6' X 50'	\$1,075/EA
\$ Includes Ballasted Chain Ends Only for Easier Portability	3GCO1230	12' X 30'	\$1,195/EA
\$ Available in 23 Different Colors with 17 Vinyl Border Color Options	3GCO1240	12' X 40'	\$1,595/EA
\$ Add Chroma-Bond® Imprinting with Team Lettering, Logos, and Advertising	3GCO1250	12' X 50'	\$1,925/EA
\$ CUSTOM Sizes, Manufactured in Standard 6' and 12' Widths	3GCOX	CUSTOM SIZES up to 800 SF	\$5.29/SF

See page 26 for CHROMA-BOND Imprinting



18 OZ. VINYL COLOR CHART

White	Grey	Beige/Tan	Black	Maroon	Red	Orange	Yellow/Gold	
Kelly Green	Midnight Green	Medium Green	Navy	Royal Blue	CC Sky Blue	Purple	Vegas Gold	Sport Grey/Charcoal

ACTUAL COLOR OF MATERIALS MAY VARY FROM EACH "LOT" / "RUN".
IF YOU ARE TRYING TO MATCH A SPECIFIC COLOR, PLEASE REQUEST A SAMPLE FROM THE CURRENT STOCK AVAILABLE FOR PRODUCTION.

VIPOL® MATRIX COLOR CHART

White	Grey	Beige/Tan	Brown	Black	Maroon	Scarlet	Red	Burnt Orange	Orange	Vegas Gold	
Gold	Yellow	Aqua	Kelly Green	Forest Green	Midnight Green	Navy	ProBlue	Royal Blue	CC Sky Blue	Purple	Sport Grey/Charcoal

ACTUAL COLOR OF MATERIALS MAY VARY FROM EACH "LOT" / "RUN".
IF YOU ARE TRYING TO MATCH A SPECIFIC COLOR, PLEASE REQUEST A SAMPLE FROM THE CURRENT STOCK AVAILABLE FOR PRODUCTION.

YOUR "ONE-STOP" SOURCE FOR AMERICA'S BASEBALL, SOFTBALL & SPORTS SURFACES & SUPPLIES!

PRICES SUBJECT TO CHANGE & AVAILABILITY PLUS SHIPPING | VOLUME DISCOUNTS AVAILABLE | COOPERATIVE PURCHASING CONTRACT PRICING FOR 50 STATES

CROSS-OVER ZONE® TRACK PROTECTORS

PROTECTS COSTLY TRACK SURFACE

These track protectors resist and cushion against cleats, shoes, and wheeled equipment ... yet allow water to drain through. Made of tough polypropylene geotextile fabric with vinyl edging with steel chain inserted all around for ballast. This keeps Protector down even in high winds without stakes. To reduce weight for easier installation, longer Sideline models have sections that join with hook-and-loop strips. Tarp body is black. Standard edging is choice of white or gold. Also available: 15 other colors of the 18 oz. vinyl edging.



CO1530	15' x 30'	90 lbs.	\$755/EA
CO1540	15' x 40'	113 lbs.	\$935/EA
CO1550	15' x 50'	136 lbs.	\$1,129/EA
CO7530	7.5' x 30'	66 lbs.	\$535/EA
CO7540	7.5' x 40'	84 lbs.	\$645/EA
CO7550	7.5' x 50'	104 lbs.	\$785/EA
COX	CUSTOM SIZES, UP TO 800 SF		\$2.58/SF
18 oz. Vinyl Border, colors other than White or Gold TPVB-C			N/C



CROSS-OVER ZONE 3G TRACK PROTECTORS

Third Generation (3G) for Unmatched Durability, Color Choice and Imprinting

Third Generation (3G) infuses a durable three-dimensional continuous nylon filament (Enka Mat) with our VIPOL® Matrix Mesh providing better cushion that **WON'T STICK TO THE TRACK**. It's **NEXT LEVEL** in all-surface protection! Add Chroma-Bond multi-color imprinting to proudly display school colors, ID and LOGO.

3GBZST1275	12 X 75	\$2,475/EA	3GCO630	6' X 30'	\$695/EA
3GBZST12100	12 X 100	\$3,145/EA	3GCO640	6' X 40'	\$895/EA
3GBZST12125	12 X 125	\$3,775/EA	3GCO650	6' X 50'	\$1,075/EA
3GBZST12150	12 X 150	\$4,395/EA	3GCO1230	12' X 30'	\$1,195/EA
3GBZSTX	CUSTOM SIZES	\$3.75/SF	3GCO1240	12' X 40'	\$1,595/EA
	greater than 801+ SF		3GCO1250	12' X 50'	\$1,925/EA
			3GCOX	CUSTOM SIZES up to 800 SF	\$5.29/SF

See page 13 for CHROMA-BOND Imprinting

See page 11 for VIPOL & Vinyl Color Options

YOUR "ONE-STOP" SOURCE FOR AMERICA'S BASEBALL, SOFTBALL & SPORTS SURFACES & SUPPLIES!

PRICES SUBJECT TO CHANGE & AVAILABILITY PLUS SHIPPING | VOLUME DISCOUNTS AVAILABLE | COOPERATIVE PURCHASING CONTRACT PRICING FOR 50 STATES

CHROMA-BOND IMPRINTING

Chroma-Bond Imprinting, 1 Color Logo Only

1COL25SF	Up to 25SF, MINIMUM SF: 20.5 SF	\$34/SF
1COL2650SF	26SF—50SF, MINIMUM SF: 37.55 SF	\$24/SF
1COL51100SF	51SF—100SF, MINIMUM SF: 66.5 SF	\$22/SF

Chroma-Bond Imprinting, 2 Color Logo Only

2COL25SF	Up to 25SF, MINIMUM SF: 20.5 SF	\$34/SF
2COL2650SF	26SF—50SF, MINIMUM SF: 37.55 SF	\$24/SF
2COL51100SF	51SF—100SF, MINIMUM SF: 66.5 SF	\$22/SF

Chroma-Bond Imprinting, 3 Color Logo Only

3COL25SF	Up to 25SF, MINIMUM SF: 20.5 SF	\$34/SF
3COL2650SF	26SF—50SF, MINIMUM SF: 37.55 SF	\$24/SF
3COL51100SF	51SF—100SF, MINIMUM SF: 66.5 SF	\$22/SF

Chroma-Bond Imprinting
Letters or Numbers

1 Color		2 Color	
1COL24	\$90/EA	2COL24	\$122/EA
1COL36	\$105/EA	2COL36	\$138/EA
1COL48	\$122/EA	2COL48	\$154/EA
1COL60	\$138/EA	2COL60	\$170/EA
1COL72	\$162/EA	2COL72	\$194/EA
1COL84	\$178/EA	2COL84	\$210/EA
1COL96	\$194/EA	2COL96	\$226/EA
1COL108	\$218/EA	2COL108	\$250/EA
1COL120	\$250/EA	2COL120	\$283/EA



Our sharp multi-color images will outlast other processes. Eliminates the historic problems of digital printing, like weathering, premature fading, scuffing, and unsightly white mesh backside color. Images will last outdoors as long as the fabric, something rarely true with digital imprinting. Also highly spike, cleat, and racquet resistant. Our thick, individually-applied, double coating process literally bonds the image into the vinyl and completely masks the underlying fabric color, so image colors are vivid and true.

Chroma-Bond imprinting is available on our vinyl-surfaced windscreen, cover, padding & sign products.



YOUR "ONE-STOP" SOURCE FOR AMERICA'S BASEBALL, SOFTBALL & SPORTS SURFACES & SUPPLIES!

PRICES SUBJECT TO CHANGE & AVAILABILITY PLUS SHIPPING | VOLUME DISCOUNTS AVAILABLE | COOPERATIVE PURCHASING CONTRACT PRICING FOR 50 STATES

STACKHOUSE HURDLES

ORDER 80+ HURDLES:
Get free freight (48 states), school name on boards and risers in school colors.



Riser Color Choices



A. Cantabrian Aluminum "INTERNATIONAL" Hurdle

- \$ Designed for College and International competition.
- \$ 2 1/2" by 2" extruded aluminum ribbed profile base with beveled edges make for sleek, stable, safe and easy stack design.
- \$ Spring loaded weights weight easily adjusts to correct pullover weight for all 5 heights.
- \$ Spring loaded riser. Adjust to 30", 33", 36", 39" & 42" height.
- \$ Poly board is double ribbed and uses UV inhibitors to help insure long board life.

TICH-ADJC F Class 92.5, 29 lbs **\$260**

B. Elite Aluminum H.S. Hurdle

- \$ Open face constructed base.
- \$ Welded one-piece aluminum base.
- \$ Grooved bases for interlocking stacking.
- \$ 5-height adjustments, 30", 33", 36", 39", & 42".

TEHS F Class 92.5, 23 lbs **\$205**

C. Elite Aluminum College Hurdle

- \$ Internal sliding weight makes hurdle legal pull over weight at all College heights.
- \$ Open face constructed base.
- \$ Welded one-piece aluminum base.
- \$ Grooved interlocking bases stabilize hurdle in transport.
- \$ 5 height adjustments: 30", 33", 36", 39" & 42"

TECH F Class 92.5 25 lbs **\$215**

D. Regal "L" Hurdle

- \$ Stackhouse's #1 selling Middle School and High School hurdle.
- \$ Meets all NFHS standards.
- \$ All Steel Construction.
- \$ Weighted to meet official turn over specifications.
- \$ Adjusts to 30", 33", 36", 39", & 42".
- \$ Silver zinc plated base & gold zinc plated risers.
- \$ 41" PVC gate board with spring-loaded risers.
- \$ Shipping discounts available for quantity.

TRLH F Class 92.5, 28 lbs **\$140**

YOUR "ONE-STOP" SOURCE FOR AMERICA'S BASEBALL, SOFTBALL & SPORTS SURFACES & SUPPLIES!

PRICES SUBJECT TO CHANGE & AVAILABILITY PLUS SHIPPING | VOLUME DISCOUNTS AVAILABLE | COOPERATIVE PURCHASING CONTRACT PRICING FOR 50 STATES

STACKHOUSE HURDLES

ORDER 80+ HURDLES:
Get free freight (48 states), school name on boards and risers in school colors.



A. Aluminum H.S. Rocker Hurdle

- \$ 5-height adjustments: 30", 33", 36", 39", 42".
- \$ Lightweight aluminum construction.
- \$ Self-adjusting weight system.
- \$ Meets pull-over requirements at all heights.
- \$ Powder coated risers provide smooth non-rigid snag free surface.
- \$ Nylock nuts attach PVC gate to riser and provide superior holding power and rigidity.
- \$ Meets all NFHS standards and pull over weights.
- \$ Shipping discounts available for quantity.

TARH F Class 92.5, 31 lbs **\$140**
(3 or less ship UPS Dimensional)

B. Cantabrian Aluminum High School Open Face hurdle

- \$ 5 height adjustments: 30", 33", 36", 39" & 42"
- \$ Welded base construction for superior strength.
- \$ 1 1/4" O.D. Aluminum tubing.
- \$ Open face approach, no rear.
- \$ No assembly necessary "ready to use".
- \$ Meets all NFHS pull over weights.
- \$ Spring loaded buttons for easy height adjustment.
- \$ Shipping discounts available in quantity.
- \$ Stackable.

TCOFH F Class 92.5, 21 lbs **\$165**

C. Aluminum One-Piece High School Rocker Hurdle

- \$ Aluminum, one-piece base eliminates bolts that can loosen
- \$ 5-height adjustments: 30", 33", 36", 39", 42"
- \$ Meets all H.S. pullover specifications for all heights and all High School federation rules.

THAER F Class 92.5, 21 lbs **\$140**

D. Junior Elementary Hurdle (1st through 6th Grades)

- Excellent for beginners and advanced training.
- \$ Sturdy steel construction.
- \$ Risers powder coated blue.
- \$ Gate height adjusts 21"- 24"- 27" & 30".
- \$ 36" wide PVC gate board.
- \$ Shipping discounts available for quantity.

TJEH F 15 lbs. Ships Dimensional **\$110**



YOUR "ONE-STOP" SOURCE FOR AMERICA'S BASEBALL, SOFTBALL & SPORTS SURFACES & SUPPLIES!

PRICES SUBJECT TO CHANGE & AVAILABILITY PLUS SHIPPING | VOLUME DISCOUNTS AVAILABLE | COOPERATIVE PURCHASING CONTRACT PRICING FOR 50 STATES

TSI / OLYMPIA HURDLES**OLYMPIA ALUMINUM SUPER HURDLE**

Professional grade, all-aluminum hurdle with a square profile base and round uprights. Meets NFHS, NCAA & IAAF specifications. Constructed with strong ribbed PVC hurdle board. Easy-glide hurdle features a weight adjust system. Stainless steel nuts and bolts and powder-coated sliding weights ensure ultimate weather protection for years of hassle-free usage. Bright colored height and weight indicator stickers. Height range 27" to 42".

HOAS

SHIPS BY TRUCK

\$345**OLYMPIA ALUMINUM COMPETITION HURDLE**

Professional grade, all-aluminum hurdle with a square profile base and round uprights. Meets NFHS, NCAA & IAAF specifications. Constructed with strong ribbed PVC hurdle board. Easy-glide hurdle features a weight adjust system. Stainless steel nuts and bolts and powder-coated sliding weights ensure ultimate weather protection for years of hassle-free usage. Bright colored height and weight indicator stickers. Height range 27" to 42".

HOAC

SHIPS BY TRUCK

\$325**CLUB ROCKER HURDLE**

The Trigon Sports Club Rocker hurdle is ideal for high school competition. Made of a strong steel frame, this hurdle features a push-button locking device to quickly adjust to your hurdling height. Comes with PVC Bar. L-shaped base controls rocker action, while sealed weights control resistance. Dual tube base ensures structural strength and easy stacking. Adjustable height range from 36" to 42".

HROCK

SHIPS BY TRUCK

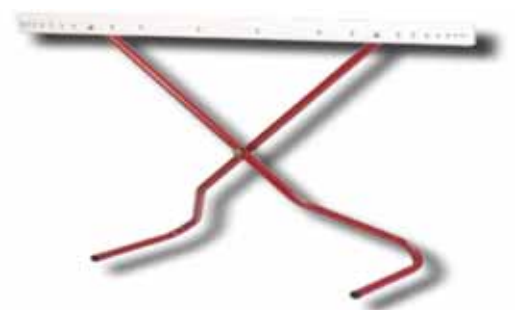
\$145**ADJUSTABLE TRAINING HURDLE**

- Adjusts to 11 different sizes from 9"-42"
- High-impact plastic crossboard
- Powder-coated 1"D steel legs
- Ideal for polymetrics, speed & agility
- Great for beginners to use
- Hurdle folds flat for easy transport & storage

HATH

SHIPS BY TRUCK

\$60

YOUR "ONE-STOP" SOURCE FOR AMERICA'S BASEBALL, SOFTBALL & SPORTS SURFACES & SUPPLIES!

PRICES SUBJECT TO CHANGE & AVAILABILITY PLUS SHIPPING | VOLUME DISCOUNTS AVAILABLE | COOPERATIVE PURCHASING CONTRACT PRICING FOR 50 STATES

Hurdle Carts / Field Wagons



Hanging Hurdle Cart

This 6 wheel cart with its heavy-duty all steel construction carries 8-14 hurdles at a time, depending on brand/model. Center wheels are slightly lowered for easy rotating. Unique design helps transport hurdles over curbs and through rough grass or loose gravel with no problems. This cart will accommodate both college and high school hurdles.

THHC

F Class 70, 121 lbs

\$690

2 Wheel Hurdle Cart

Place hurdles in a stack, slide hurdle cart underneath, tilt hurdles back on 2 pneumatic wheels. Steel construction. Holds 8 -10 hurdles.

TH2WD

UPS 35 lbs

\$520



Super Field Wagon

Same features as TFW510. Constructed of tread-plate, rust free aluminum surface and frame.

TFAC510

1000 lb. capacity. 5' x 10'
F Class 100, 234 lbs

\$2,410

TFAC48

1000 lb. capacity. 4' x 8'
F Class 100, 178 lbs

\$1,910

Field Wagon

Transport all pits, hurdles, standards, and more! Industrial grade front axle swivel provides ease in steering. Heavy-duty plywood floor recessed in steel frame. 16" fully pneumatic tires. Can be used behind a small tractor.

TFW510

1000 lb. capacity. 5' x 10'
F Class 100, 275 lbs

\$1,945

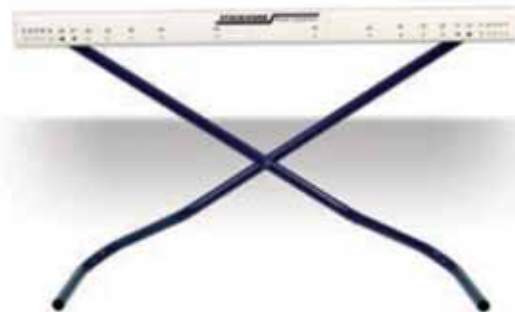

Cantabrian Flight Hurdle Cart

4 wheel design. Swivel wheels at back for easy steering. Holds up to 10 hurdles. Steel construction. Black powder coat finish. College

THFC

UPS 35 lbs

\$310

Adjustable Height Training Hurdle

Great tool for plyometric and hurdling exercises. Adjusts from 6"- 42". Frame is made of durable steel tube and uses plastic crossbar for a long lasting, easy to use training aid. Folds easy for storage and inexpensive UPS shipping.

TAJDH

UPS 8 lbs

\$48

YOUR "ONE-STOP" SOURCE FOR AMERICA'S BASEBALL, SOFTBALL & SPORTS SURFACES & SUPPLIES!

PRICES SUBJECT TO CHANGE & AVAILABILITY PLUS SHIPPING | VOLUME DISCOUNTS AVAILABLE | COOPERATIVE PURCHASING CONTRACT PRICING FOR 50 STATES

Starting Blocks

Starting Blocks

A. Championship Starting Block

- \$ 5" wide 4-position adjustable pedals.
- \$ 2.5" center rail.
- \$ Lightweight aluminum construction.
- \$ Fitting High School and College competition.
- \$ All-weather spikes included.

TCHAMP UPS 11 lbs

\$135

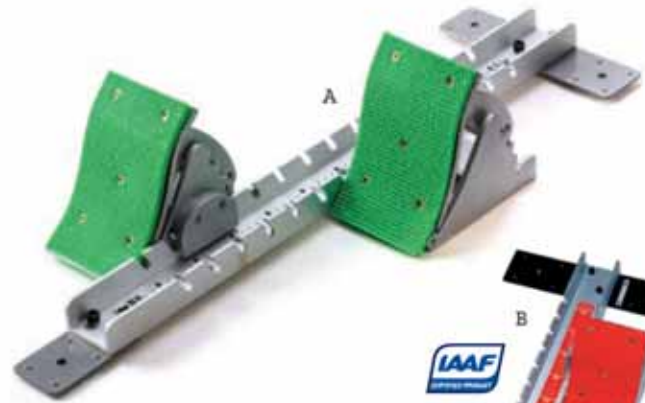

B. Cheetah Elite Aluminum Starting Block

- \$ 5" wide 4-position adjustable pedals.
- \$ 3" center rail.
- \$ Lightweight aluminum construction.
- \$ Fitting Collegiate and International competition.
- \$ All-weather spikes included.

TCEB UPS 16 lbs

\$195

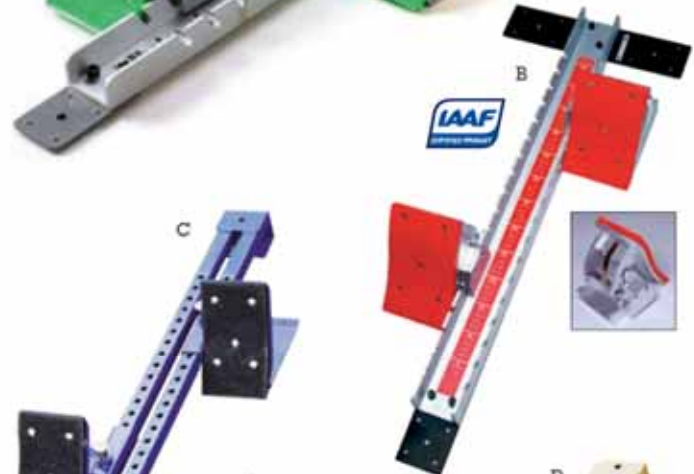

C. Olympia Adjustable Starting Block

- \$ 4" wide adjustment pedals.
- \$ Pedal adjusts to virtually ANY angle!
- \$ Snap lock plunger locks pedals into position quickly.
- \$ Includes all-weather and anchor spikes with adjustment wrench.

TOLY UPS 12 lbs

\$76

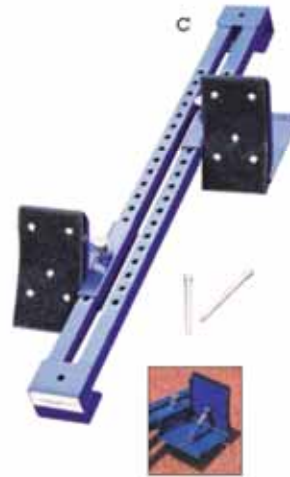

D. Speed Star Starting Block

- \$ Adjustment pins are spring loaded so pedals can be quickly moved.
- \$ Includes all-weather spikes.

TSTAR UPS 11 lbs

\$80

E. Indoor Starting Blocks (pair)

- \$ Red rubber blocks (color may vary).
- \$ Adhere to any clean floor without glue.
- \$ NO holes in floor.
- \$ Removes easily from floor surface.

TISB UPS 9 lbs

\$35

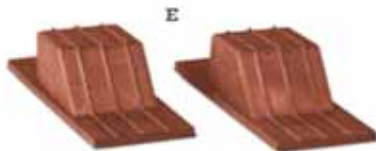

F. Heavy Duty Starting Block Cart

- \$ Holds up to 12 blocks.
- \$ Large rubber tires for an easy roll.
- \$ User-friendly extended handle.
- \$ Metal tray for extra storage.

TSBC2 UPS 79 lbs

\$910



G. Starting Block Cart

- \$ Holds 12 starting blocks.
- \$ 3" swivel rubber wheel casters.
- \$ Steel construction.
- \$ Large base tray for storage.

TSECON UPS 58 lbs

\$305



YOUR "ONE-STOP" SOURCE FOR AMERICA'S BASEBALL, SOFTBALL & SPORTS SURFACES & SUPPLIES!

PRICES SUBJECT TO CHANGE & AVAILABILITY PLUS SHIPPING | VOLUME DISCOUNTS AVAILABLE | COOPERATIVE PURCHASING CONTRACT PRICING FOR 50 STATES

Starting Blocks

H. Cantabrian Gran Prix Starting Block

Pursue your passion with ultimate quality. Eight inch square five angle pedal face. Customize with 35, 45, 55, 60, or 65 degree angle. Angle makes a big difference how you come out of the block. You come out running. You're not working. Your torso is carrying you. You get a better push off. Proper shin angles and flex response. Your hips and torso are higher. Perfect block to develop, refine, and improve your technique, strength, and speed. Take advantage of your training. Push thru the post. Drive off the block with your power leg.

- \$ Easy Carry center handle.
- \$ Pedals will not come off block in transit.
- \$ Easy to change threaded spike inserts.
- \$ Ideal for International and Collegiate competition.
- \$ Meets NFHS regulations and is IAAF certified. [hide]

College/ Elite High Schools
TCGP UPS 16 lbs

\$440

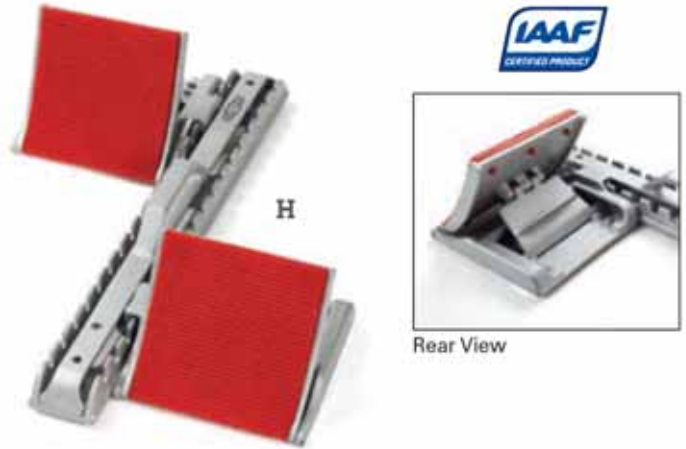

I. Cantabrian Catapult Starting block

- \$ Forged aluminum pedals. 11" x 6" pedals. Adjust to 5 angles - 35, 45, 55, 60 & 65 degree settings. Black powder coated attractive finish. Wedged side plates lock into rail.
- \$ Sleek designed center rail. 3 1/4" wide. 3/8" extruded aluminum. Easy lock adjustment notches. Infinite adjustment locations. Scale down center rail. Easy space and visual adjustment. Carry handle for moving and storage.
- \$ Black powder coated end plates. Tapped to take regular track shoe spike size. Usable on any surface.

TCCAT UPS 13 lbs

\$300

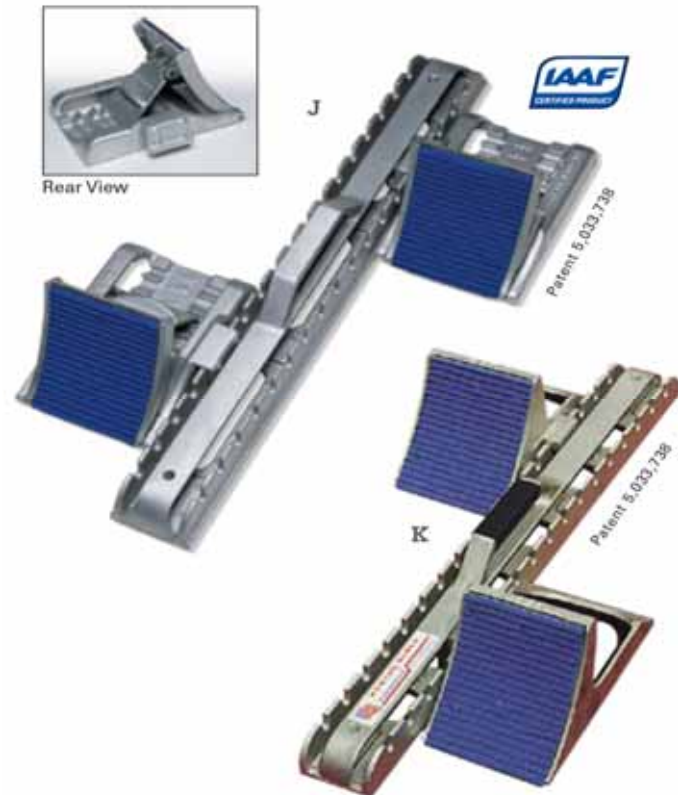
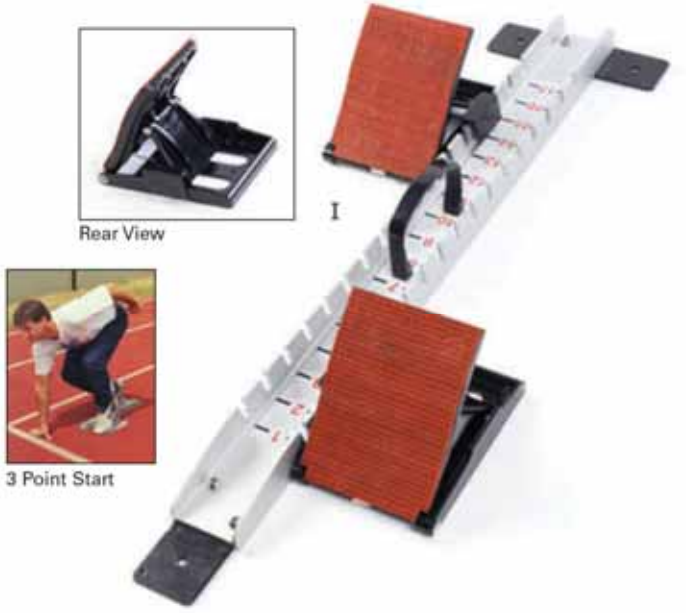

J. Newton International "BEST" "The Real Thing!"

- \$ Highest quality Collegiate and International starting system.
- \$ High quality light-weight all Aluminum casting.
- \$ 5 pedal angle adjustments 35°, 45°, 55°, 60° and 65°.
- \$ Easy carry center rail.
- \$ Pedals will not come off rail during transport.
- \$ Pedals have threaded spike inserts - "easy changes outs".
- \$ Includes threaded spikes for synthetic surface.

T1008 UPS 14 lbs

\$410

K. Newton Elite "Better"

- \$ High quality light-weight all Aluminum casting.
- \$ Easy carry center rail.
- \$ Pedals will not come off rail during transport.
- \$ Pedals have threaded spike inserts - "easy change outs!".

T1007 UPS 13 lbs

\$255

YOUR "ONE-STOP" SOURCE FOR AMERICA'S BASEBALL, SOFTBALL & SPORTS SURFACES & SUPPLIES!

PRICES SUBJECT TO CHANGE & AVAILABILITY PLUS SHIPPING | VOLUME DISCOUNTS AVAILABLE | COOPERATIVE PURCHASING CONTRACT PRICING FOR 50 STATES

Starting Blocks

OLYMPIC PRO STARTING BLOCK

The Olympic Block is a super heavy-duty block especially designed for professional athletes. All aluminum block with center rail 4" wide x 35" long and slotted angles to firmly grip pedals. Adjustable at four different angles. All pedals fitted with special thick rubber to take in spikes. Suitable block for synthetic track. Comes with steel plates. Flushed to center rail. Meets NFHS, NCAA & IAAF specifications.

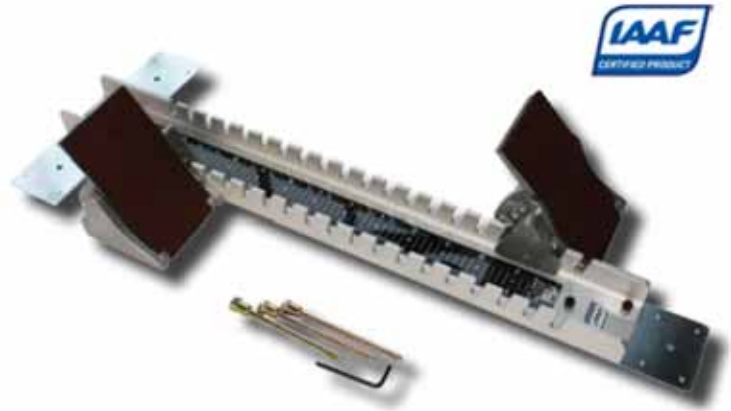
SBPRO**\$345**

OLYMPIC STADIUM STARTING BLOCK

Another version of our Olympic block with light aluminum pedals and 3" aluminum center rail. Detachable and adjustable aluminum pedals. Meets NFHS, NCAA & IAAF specifications.

SBSTAD**\$280**

OLYMPIC ELITE ALUMINUM STARTING BLOCK

An economy Olympic block for high school competition. Features a 2.5" aluminum center rail and aluminum pedals. Detachable and adjustable aluminum pedals. Meets NFHS, NCAA & IAAF specifications.

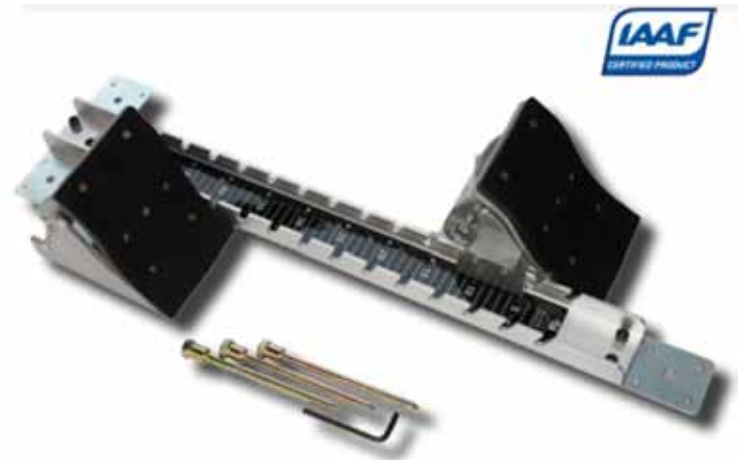
SBELITE**\$190**

YOUR "ONE-STOP" SOURCE FOR AMERICA'S BASEBALL, SOFTBALL & SPORTS SURFACES & SUPPLIES!

PRICES SUBJECT TO CHANGE & AVAILABILITY PLUS SHIPPING | VOLUME DISCOUNTS AVAILABLE | COOPERATIVE PURCHASING CONTRACT PRICING FOR 50 STATES

LONG & TRIPLE JUMP PIT SURFACES



YOUR "ONE-STOP" SOURCE FOR AMERICA'S BASEBALL, SOFTBALL & SPORTS SURFACES & SUPPLIES!

PRICES SUBJECT TO CHANGE & AVAILABILITY PLUS SHIPPING | VOLUME DISCOUNTS AVAILABLE | COOPERATIVE PURCHASING CONTRACT PRICING FOR 50 STATES

LANDING ZONE™ BALLASTED PIT COVERS
KEEPS SAND IN and KIDS AND ANIMALS OUT!

Made with our exclusive Vipol® Matrix Mesh Material, the Landing Zone™ Ballasted Pit Covers are tough beyond belief. Your sand stays where it belongs, in the pit, protected from wind, animals, and children. But rain, sun, and air penetrate the material, eliminating water pooling and mold. Also available in reinforced solid vinyl.



Galvanized steel chain is installed in the edge hem all around, providing enough ballast to keep wind from getting under. These covers **STAY PUT IN HIGH WINDS** without stakes or sandbags.

LZXVIPOL LZ Ballasted Pit Cover made with 10 oz. Vipol™ Matrix Mesh—Available in 23 colors!

\$3.75/SF

LZXVINYL LZ Ballasted Pit Cover made with 18 oz. Solid Vinyl—Available in 17 colors!

\$3.55/SF

CHROMA-BOND imprinting available see page 15

Sizes: All Landing Zone™ Ballasted Pit Covers are CUSTOM sized.

VIPOL® MATRIX COLOR CHART

White	Grey	Beige/Tan	Brown	Black	Maroon	Scarlet	Red	Burnt Orange	Orange	Vegas Gold	
Gold	Yellow	Aqua	Kelly Green	Forest Green	Midnight Green	Navy	ProBlue	Royal Blue	CC Sky Blue	Purple	Sport Grey/ Charcoal

18 OZ. VINYL COLOR CHART

White	Grey	Beige/Tan	Black	Maroon	Red	Orange	Yellow/Gold	
Kelly Green	Midnight Green	Medium Green	Navy	Royal Blue	CC Sky Blue	Purple	Vegas Gold	Sport Grey/Charcoal

ACTUAL COLOR OF MATERIALS MAY VARY FROM EACH "LOT" / "RUN".
IF YOU ARE TRYING TO MATCH A SPECIFIC COLOR, PLEASE REQUEST A SAMPLE FROM THE CURRENT STOCK AVAILABLE FOR PRODUCTION.

YOUR "ONE-STOP" SOURCE FOR AMERICA'S BASEBALL, SOFTBALL & SPORTS SURFACES & SUPPLIES!

PRICES SUBJECT TO CHANGE & AVAILABILITY PLUS SHIPPING | VOLUME DISCOUNTS AVAILABLE | COOPERATIVE PURCHASING CONTRACT PRICING FOR 50 STATES

WEIGHTED LONG JUMP PIT COVERS

SAVE THE COST OF MAINTAINING JUMP PITS!

Features

- Weighted around perimeter – requires no sandbags or stakes
- Available with either steel ball bearings or steel chain in heat-sealed hem all around perimeter.
- Available in standard sizes or custom.
- Printable 18 oz. or 14 oz.



18 oz. Solid

14 oz. ArmorMesh



Fabrics	18 oz. Solid Vinyl	14 oz. ArmorMesh
Properties	Waterproof 14 colors	Heavy-duty allows for water penetration and keeps out debris. 13 colors



WARRANTY
Weighted Long Jump Pit Covers:
Solid Vinyl & Armor Mesh—
3 year warranty.
Polyethylene—2 year warranty

18 oz. Solid Vinyl With Heat-Sealed Hem

Standard Sizes

12' x 28'	VCPPIT12X28	\$650
12' x 30'	VCPPIT12X30	\$695
12' x 32'	VCPPIT12X32	\$725
12' x 34'	VCPPIT12X34	\$775
Custom Size	VCPPITCUST	\$2.20/SF

14 oz. Premium ArmorMesh With Heat-Sealed Hem

Standard Sizes

12' x 28'	AMPIT12X28	\$605
12' x 30'	AMPIT12X30	\$665
12' x 32'	AMPIT12X32	\$700
12' x 34'	AMPIT12X34	\$735
Custom Size	AMPITCUST	\$2.00/SF



WEIGHTED EDGE



STANDARD FEATURE

Weighted edge on ArmorMesh



OPTIONAL PRINTING

**LETTERING
ONE OR
MULTI-COLORED**

12" H	LETTER12	\$32
14" H	LETTER14	\$34
18" H	LETTER18	\$40
24" H	LETTER 24	\$45
30" H	LETTER30	\$54
36" H	LETTER36	\$62
42" H	LETTER42	\$74
48" H	LETTER48	\$85
54" H	LETTER54	\$99
60" H	LETTER60	\$114
72" H	LETTER72	\$130
84" H	LETTER84	\$145
Minimum	LETTERMC	\$295

**CUSTOM LOGOS/
ONE OR MULTI-COLORED
COLORED**

Up to 15 SF (ex. 3' x 5')	LOGO15	\$295
Up to 30 SF (ex. 5' x 6')	LOGO30	\$395
Up to 50 SF (ex. 5' x 10')	LOGO50	\$565
Up to 100 sf (ex. 10' x 10')	LOGO100F	\$995

YOUR "ONE-STOP" SOURCE FOR AMERICA'S BASEBALL, SOFTBALL & SPORTS SURFACES & SUPPLIES!

PRICES SUBJECT TO CHANGE & AVAILABILITY PLUS SHIPPING | VOLUME DISCOUNTS AVAILABLE | COOPERATIVE PURCHASING CONTRACT PRICING FOR 50 STATES

TAKE-OFF & TOE BOARDS



Tray System

This 8" wide tray system is the most popular tray system for both the college and high school market. The 8" wide board meets all the specifications for college and high school. The weatherproof high-density urethane top surface of the board makes an excellent take off surface. The take-off board is mounted to a steel framework with 6 adjusting bolts so that you can level the board with the runway surface. The heavy-duty tray is made of bright zinc plated steel.

TTSS UPS 75 lbs **\$670**



side view

Poly High School Take-Off Board

New problem solving technology poly take-off board eliminates durability and cracking problems often experienced in wood boards. Long lasting poly surface comes with a 5-year warranty. This two part poly board has a softer texture 3/4" top board for better plants. Attached to high density 3/4" grey poly under board to eliminate warping.

TPOLYTB UPS 48 lbs **\$340**



Tray for TPOLYTB

For permanent installation in synthetic runways, this 48" x 20" stainless steel tray system works with our TPOLYTB take-off board. Drain holes for all weather conditions.

THSTBT UPS 36 lbs **\$470**



A

B



International Take-Off Tray System

Made the same as our TTSS board with the addition of a foul board and cover. Foul board is made of 1/2" plywood and can easily be taken out and plasticine put in for meets. Cover is made of heavy-duty steel.

TTICS UPS 105 lbs **\$1,370**



side view

Long Jump/Triple Jump Take-Off Board

This official take-off board is made with the same technology as our TPOLYTB board. 48" long by 8" wide. 3/4" polyurethane top surface on 1 1/2" x 8" plastic underboard.

TLT Ups 24 lbs **\$245**



Counter sunk for bolt & washer.

Recessed for ring

Poly Toe Board

Our Poly Toe Board is designed with Linear Low-Density Polyethylene (LLDPE) and UV stabilizer for maximum durability. This design eliminates the potential for rusting, common in metal boards, and its solid construction prevents chipping and cracking often seen with wood or fiberglass boards.

TPTB Ups 15 lbs **\$375**

A. Cast Aluminum Toe Board

Cast aluminum construction, meets all rule specifications. Designed for level pads.

TATB For level pad (most common), UPS 24 lbs **\$565**
TATB-DP Depressed pad, UPS 24 lbs **\$565**

B. All Metal Shot Toe Board

Cannot warp, split, or deteriorate in weather. Radiating lines speed up accurate measurement.

TMTB UPS 25 lbs **\$255**



YOUR "ONE-STOP" SOURCE FOR AMERICA'S BASEBALL, SOFTBALL & SPORTS SURFACES & SUPPLIES!

PRICES SUBJECT TO CHANGE & AVAILABILITY PLUS SHIPPING | VOLUME DISCOUNTS AVAILABLE | COOPERATIVE PURCHASING CONTRACT PRICING FOR 50 STATES

High Jump Value Packages



Elementary High Jump

Elementary School High Jump Value Package

- Includes:
- 1-TH612 Elementary high jump pit.
 - 1-TH612A Elementary high jump pit all weather cover.
 - 1-TBS pair budget high jump standards.
 - 1-TFG13-1 13' 1 1/2" fiberglass crossbar.
 - 13 YEAR WARRANTY

TVPEHJ F Class 250, 189 lbs **\$3,640**



H.S. High Jump

H.S. High Jump Value Package

- Includes:
- 1-TH816 Challenger high jump pit.
 - 1-TH816A Challenger high jump pit all weather cover.
 - 1-TRSS pair steel roll away high jump standards.
 - 1-TFG13-1 13' 1 1/2" fiberglass crossbar.
 - 13 YEAR WARRANTY

TVPHHJ F Class 250, 389 lbs **\$7,600**



International High Jump

H.S. Cut-out High Jump Value Package

- Includes:
- 1-THC1016 Challenger cut-out high jump pit.
 - 1-THC1016A Challenger high jump pit all weather cover.
 - 1-TRSS pair steel roll away high jump standards.
 - 1-TFG13-1 13' 1 1/2" fiberglass crossbar.
 - 13 YEAR WARRANTY

TVPOHJ F Class 250, 445 lbs **\$9,200**

International High Jump Value Package by Cantabrian

- Includes:
- 1-THCO1018 International high jump pit.
 - 1-THCO1018A International high jump pit all weather cover.
 - 1-TRASC pair aluminum roll away high jump standards.
 - 1-TFG13-1 13' 1 1/2" fiberglass crossbar.
 - 13 YEAR WARRANTY

TVPCHJ F Class 250, 450 lbs **\$10,605**

H.S. Pole Vault Value Package

- Includes:
- 1-TP2021 Champion pole vault pit.
 - 1-TP2021A all weather cover.
 - 1-TPVS6 pair pole vault standards 6' - 18'.
 - 1-TFG14-1 14' 10" fiberglass crossbar.
 - 1-TTPAD pole vault standard pad.
 - 13 YEAR WARRANTY

TVPHPV F Class 250, 450 lbs **\$20,000**



YOUR "ONE-STOP" SOURCE FOR ALL YOUR TRACK & FIELD EQUIPMENT NEEDS

PRICES SUBJECT TO CHANGE & AVAILABILITY PLUS SHIPPING | VOLUME DISCOUNTS AVAILABLE | COOPERATIVE PURCHASING CONTRACT PRICING FOR 50 STATES

High Jump Pits

ELEMENTARY/PROVIDENCE HIGH JUMP SYSTEMS

- Made In America by Stackhouse.
- Buy American Quality.
- Sixty Five Years on.
- Thirteen Year Warranty backed by American Sweat, Materials, and Workmanship.
- American made Earth-Cell foam. Exclusive and Trademarked.
- Produced from renewable resources such as Soy.
- Reduces America's dependency on fossil fuels.
- Lessens energy demand for a smaller environmental footprint
- Comfort. Protection. Performance
- Outstanding (Colors won't fade) UV Protection
- Excellent Strength and Wear Longevity
- Comfort Carry Handles.
- Made to Order: Guarantee ship within 1-2 weeks



Providence High Jump Pit



Providence High Jump Pit

Ideal high jump pit for High School or Middle School looking for the best buy on a pit not containing a top pad. Meets all High School Specifications. Pit uses a mesh "table cloth" style skirt to hold buns together. Comes in 12 colors and is 16' x 8' x 24". Guaranteed satisfaction with a 13 year warranty.

TB816	F Class 250, 235 lbs	\$4,440
TB816A	All Weather Cover, UPS 30 lbs	\$650
TB816G	Ground Cover, UPS 30 lbs	\$399

Providence High Jump Value Package

- Includes:
- 1-TB816 Providence high jump pit.
 - 1-TB816A Providence high jump pit all weather cover.
 - 1-TBS pair budget high jump standards.
 - 1-TFG13-1 13' 1 1/2" fiberglass crossbar.
 - 13 YEAR WARRANTY

TVPBHJ	F Class 250, 309 lbs	\$5,440
---------------	----------------------	----------------

Elementary High Jump System

- Available in "Straight Front" design.
- Not intended for High School use.
- 1 piece base section.
- 13 YEAR WARRANTY. 12' W x 6' D x 24" H; pit

TH612	F Class 250, 115 lbs	\$2,810
TH612A	All Weather Cover, UPS 30 lbs	\$399
TH612G	Ground Cover, UPS 30 lbs	\$320

Elementary School High Jump Value Package

- Includes:
- 1-TH612 Elementary high jump pit.
 - 1-TH612A Elementary high jump pit all weather cover.
 - 1-TBS pair budget high jump standards.
 - 1-TFG13-1 13' 1 1/2" fiberglass crossbar.
 - 13 YEAR WARRANTY

TVPEHJ	F Class 250, 189 lbs	\$3,640
---------------	----------------------	----------------



Elementary High Jump Pit

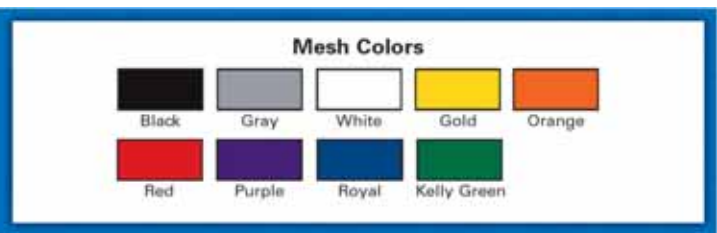

YOUR "ONE-STOP" SOURCE FOR AMERICA'S BASEBALL, SOFTBALL & SPORTS SURFACES & SUPPLIES!

PRICES SUBJECT TO CHANGE & AVAILABILITY PLUS SHIPPING | VOLUME DISCOUNTS AVAILABLE | COOPERATIVE PURCHASING CONTRACT PRICING FOR 50 STATES

High Jump Pits



Challenger Straight Front High Jump Pit

H.S. High Jump Value Package

- Includes:
- 1-TH816 Challenger high jump pit.
 - 1-TH816A Challenger high jump pit all weather cover.
 - 1-TRSS pair steel roll away high jump standards.
 - 1-TFG13-1 13' 1 1/2" fiberglass crossbar.
 - 13 YEAR WARRANTY

TVPHJ F Class 250, 389 lbs **\$7,615**

Challenger High Jump System

- Meets NFHS Standards.
- Available in "Straight Front" design.
- 3 base sections are buckled at ends, and seams are covered with 3" Velcro strips. The sections are covered by a 2" top pad.
- 13 YEAR WARRANTY.

TH816 16' 6" W x 8' D x 26" H; pit and top pad F Class 250, 284 lbs **\$6,200**
TH816A All Weather Cover, UPS 33 lbs **\$814**
TH816G Ground Cover, UPS 33 lbs **\$399**

H.S. Cut-out High Jump Value Package

- Includes:
- 1-THC1016 Challenger cut-out high jump pit.
 - 1-THC1016A Challenger high jump pit all weather cover.
 - 1-TRSS pair steel roll away high jump standards.
 - 1-TFG13-1 13' 1 1/2" fiberglass crossbar.
 - 13 YEAR WARRANTY

TVPOHJ F Class 250, 445 lbs **\$9,340**

Challenger High Jump System - Cut-out Front

- Meets NFHS Standards.
- Also available in "Straight Front" design.
- 3 base sections are buckled at ends, and seams are covered with 3" Velcro strips. The sections are covered by a 2" top pad.
- 13 YEAR WARRANTY.

THCO1016 16' 6" W x 8' D x 26" H; pit and top pad **\$7,600**
THCO1016A All Weather Cover **\$1,070**
THCO1016G Ground Cover **\$600**



Challenger Cut-out Front High Jump Pit

HIGH SCHOOL / CHALLENGER HIGH JUMP SYSTEMS

- Made In America by Stackhouse.
- Buy American Quality.
- Sixty Five Years on.
- Thirteen Year Warranty backed by American Sweat, Materials, and Workmanship.
- American made Earth-Cell foam. Exclusive and Trademarked.
- Produced from renewable resources such as Soy.
- Reduces America's dependency on fossil fuels.
- Lessens energy demand for a smaller environmental footprint
- Comfort. Protection. Performance
- Outstanding (Colors won't fade) UV Protection
- Excellent Strength and Wear Longevity
- Comfort Carry Handles.
- Made to Order: Guarantee ship within 1-2 weeks

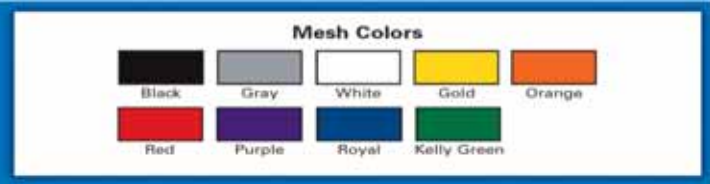

YOUR "ONE-STOP" SOURCE FOR AMERICA'S BASEBALL, SOFTBALL & SPORTS SURFACES & SUPPLIES!

PRICES SUBJECT TO CHANGE & AVAILABILITY PLUS SHIPPING | VOLUME DISCOUNTS AVAILABLE | COOPERATIVE PURCHASING CONTRACT PRICING FOR 50 STATES



High Jump Pits



International High Jump System by Cantabrian



- Meets NCAA, IAAF & NFHS Standards.
- Available in "Front Cut-Out" and "Straight Front" designs.
- 3 base sections are buckled and seams covered with 3" Velcro strips and 2" top pad.
- 13 YEAR WARRANTY.

THSF1018	18' W x 10' D x 26" H, Straight Front, pit and top pad. F Class 250, 374 lbs	\$8,375
THSF1018A	Straight Front All Weather Cover UPS 33 lbs	\$1,100
THSF1018G	Straight Front Ground Cover UPS 33 lbs	\$1,024
THCO1018	18' W x 10' D x 26" H, Front Cut-Out, pit and top pad. F Class 250, 374 lbs	\$8,440
THCO1018A	Front Cut-Out All Weather Cover UPS 33 lbs	\$1,200
THCO1018G	Front Cut-Out Ground Cover UPS 33 lbs	\$1,070

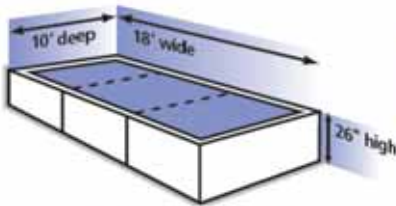

Straight front

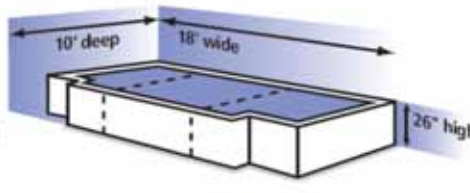

Cut-out



International High Jump Value Package by Cantabrian

Includes:

- 1-THCO1018 International high jump pit.
- 1-THCO1018A International high jump pit all weather cover.
- 1-TRASC pair aluminum roll away high jump standards.
- 1-TFG13-1 13' 1 1/2" fiberglass crossbar.
- 13 YEAR WARRANTY

TVPCHJ	F Class 250, 450 lbs	\$11,160
---------------	----------------------	-----------------

INTERNATIONAL HIGH JUMP SYSTEM BY CANTABRIAN

- Made In America by Stackhouse.
- Buy American Quality.
- Sixty Five Years on.
- Thirteen Year Warranty backed by American Sweat, Materials, and Workmanship.
- American made Earth-Cell foam. Exclusive and Trademarked.
- Produced from renewable resources such as Soy.

- Reduces America's dependency on fossil fuels.
- Lessens energy demand for a smaller environmental footprint
- Comfort. Protection. Performance
- Outstanding (Colors won't fade) UV Protection
- Excellent Strength and Wear Longevity
- Comfort Carry Handles.
- Made to Order: Guarantee ship within 1-2 weeks



YOUR "ONE-STOP" SOURCE FOR AMERICA'S BASEBALL, SOFTBALL & SPORTS SURFACES & SUPPLIES!

PRICES SUBJECT TO CHANGE & AVAILABILITY PLUS SHIPPING | VOLUME DISCOUNTS AVAILABLE | COOPERATIVE PURCHASING CONTRACT PRICING FOR 50 STATES

High Jump Standards



Telescoping Riser



Telescoping Riser



Adjustable Height

Cantabrian Elite International Rollaway High Jump standards

- Features unique 4" x 4 1/2" aluminum extruded profile.
- Internal key adjusts upright crossbar rest to telescope at desired height.
- "Brake shoe" design locks upright at desired height.
- Easily adjusts from 2' - 9' measurements in both Standard and Metric.
- Powder coated steel rollaway base.
- Easy turn adjustment knobs for leveling base.
- Meets IAAF, NCAA & NFHS rules.

TCEIR (each) UPS (1) 52 lbs ships dimensional, (1) 62 lbs **\$1,110**

Cantabrian Aluminum Rollway High Jump Standards

- High Quality 3" Diameter Aluminum extrusion uprights use internal guide for telescoping crossbar riser. Easy spin knob to lock in height and height adjustment finger insures accurate reading of measurement tape.
- Height adjusts from 2' - 8' in 1/4" increments also have metric scale form 69 - 250 cm. Gives measurement for both upper and lower crossbar rest.
- Powder coated Steel T-Base uses counter balance weight to keep base from rocking. Uses easy adjust leveling screws for quick set up on any surface.
- 24" base with rollaway feature makes for easy taking on and off the field.
- Meets all NFHS, NCCA & IAAF Specifications. Ideal for High School and College use.

TRASC (pair) UPS (2) pkgs, (1) 28 lbs, (1) 9 lbs **\$795**

YOUR "ONE-STOP" SOURCE FOR AMERICA'S BASEBALL, SOFTBALL & SPORTS SURFACES & SUPPLIES!

PRICES SUBJECT TO CHANGE & AVAILABILITY PLUS SHIPPING | VOLUME DISCOUNTS AVAILABLE | COOPERATIVE PURCHASING CONTRACT PRICING FOR 50 STATES

High Jump Standards



A. Budget High Jump Standard

- Water Resistant enamel finish.
- Adjusts from 1' to 7' in 1/4" intervals.
- Economical purchase!

TBS Pair UPS 2 pkgs, (1) 8 lbs
Ships Dimensional, (1) 30 lbs

\$245

B. Excelsior High Jump Standard

- Zinc plated water resistant uprights.
- Heavy-duty base.
- Suitable for H.S. or College.
- Adjusts from 2' to 8' in 1/4" intervals.
- Metric scale in cm 62 to 244.

TEXS Pair UPS 2 pkgs, (1) 25 lbs, (1) 36 lb

\$450

C. Steel Roll Away High Jump Standard

- Zinc plated water resistant uprights.
- 16" base with roll away feature.
- Suitable for H.S. or College.
- Adjusts from 2' to 8' in 1/4" intervals.
- Metric scale in cm 62 to 244.

TRSS Pair UPS 2 pkgs, (1) 26 lbs, (1) 40 lb

\$705

D. Premier High Jump Standards

- Stackhouse's premiere H.J. standard!
- Meets IAAF, NCAA & NFHS rules.
- 2.5" D X 5.5" W aluminum uprights with telescoping riser.
- Steel roll away base with adjusting leveling screws.
- Adjusts from 1.5' to 9'.
- Measurements in Standard and Metric.

TOHJS Pair UPS 2 pkgs, (1) 45 lbs
Ships Dimensional, (1) 62 lbs

\$1,025

YOUR "ONE-STOP" SOURCE FOR AMERICA'S BASEBALL, SOFTBALL & SPORTS SURFACES & SUPPLIES!

PRICES SUBJECT TO CHANGE & AVAILABILITY PLUS SHIPPING | VOLUME DISCOUNTS AVAILABLE | COOPERATIVE PURCHASING CONTRACT PRICING FOR 50 STATES

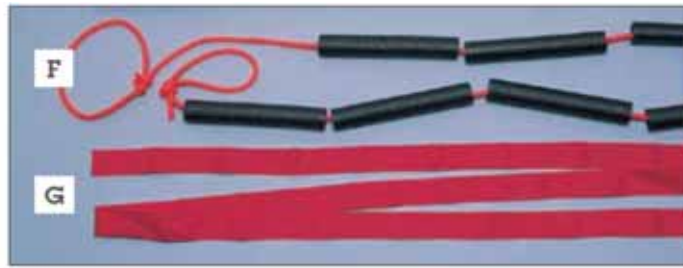
High Jump & Pole Vault Accessories**E. Stackhouse Official Fiberglass Crossbar**

TFG13-1	13' 1 1/2" competition, 6 lbs. F Class 70	\$115
TFG14-1	14' 10" competition, 6 lbs. F Class 70	\$120
TFP-13	13' 1 1/2" practice, 6 lbs. F Class 70	\$95
TFP-14	14' 10" practice, 6 lbs. F Class 70	\$96

F. Elastic Practice Crossbar

Fluorescent orange crossbar has 1 1/2" polyfoam sections to simulate actual size of official crossbar. Speeds up practice, saves crossbar and prevents injuries from falling crossbars. For use with pole vault or high jump.

TEPCB	UPS 1 lb	\$32
--------------	----------	------

G. Nylon Break Away Crossbar for High Jumper

Upon contact hook and loop connection gives way, letting nylon crossbar fall to ground. Excellent for training and practice. Reduces injuries. Uses hook and loop for breakaway and to adjust length.

TNTC	UPS 1 lb	\$43
-------------	----------	------

H. High Jump Measure

THJM	High jump; 3' 1" to 8' 3"	UPS 4 lbs.	\$305
-------------	---------------------------	------------	-------

I. Pole Vault Measure

TPVM	Pole vault; 4' 9" to 20' 4"	UPS 6 lbs	\$330
-------------	-----------------------------	-----------	-------

J. Adjustable Crossbar Lifter

Extends crossbar to 15'6"

TACL	UPS 2 pkgs, (1) 10 lbs + AH, (1) 3 lb	\$195
-------------	---------------------------------------	-------

K. Crossbar Center Lifter

This all-steel lifter addresses the need for only one person to put up a crossbar. Simply screw the lifter to a broken crossbar or pole and it's ready for use. Handle and screws not included.

TCBCL	UPS 3 lbs	\$85
--------------	-----------	------

L. Crossbar End Lifter

Made to slide over the end of any vaulting pole, this lifter is the most convenient on the market.

TCBEL	UPS 5 lbs	\$35
--------------	-----------	------

YOUR "ONE-STOP" SOURCE FOR AMERICA'S BASEBALL, SOFTBALL & SPORTS SURFACES & SUPPLIES!

PRICES SUBJECT TO CHANGE & AVAILABILITY PLUS SHIPPING | VOLUME DISCOUNTS AVAILABLE | COOPERATIVE PURCHASING CONTRACT PRICING FOR 50 STATES

POLE VAULT PITS



Double-sided coaches box offers twice the life.

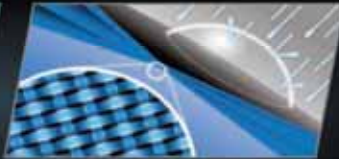

Extra-tough monster mesh resists tearing. Vinyl-coated polyester yarn offers superior water-repelling characteristics.



Reinforced flaps boast a 3" Velcro locking system.

3 back buns are interchangeable to evenly distribute wear.

Top pad cut out showing flap.

Zinc coated, rust resistant snap rings and snap hooks

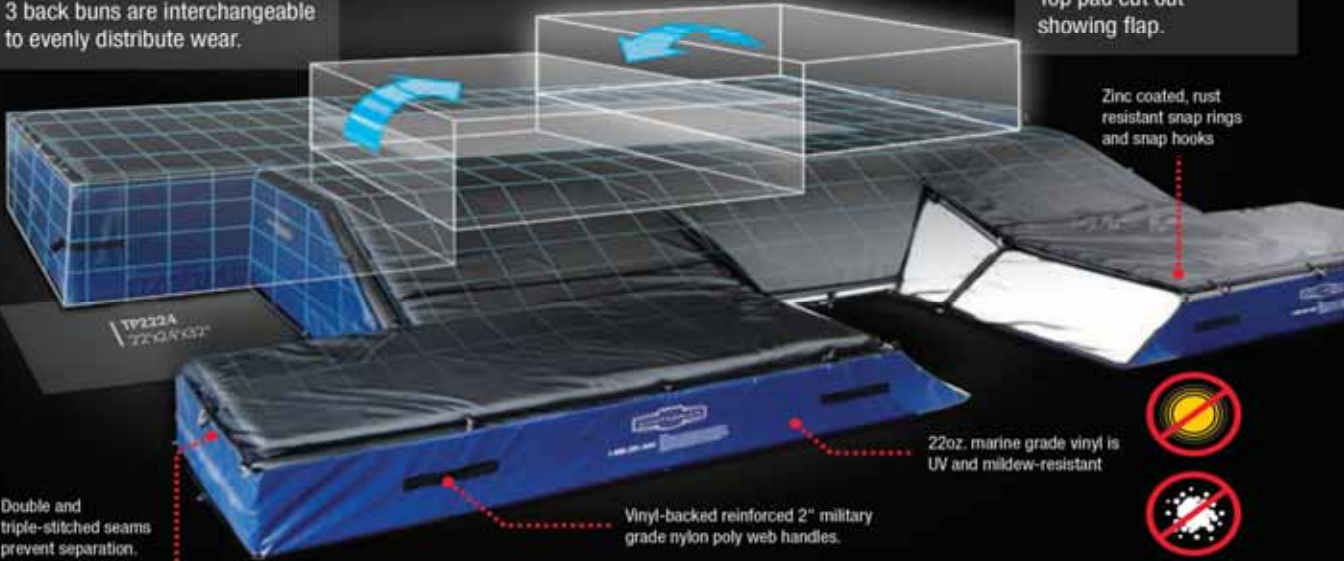

TP2224 22'x9'x10'2"

Double and triple-stitched seams prevent separation.

Vinyl-backed reinforced 2" military grade nylon poly web handles.

22oz. marine grade vinyl is UV and mildew-resistant



Patented Earthcell™ foam is a flexible bio-based alternative to petroleum-based padding. Its superior performance comes from enhanced cell integrity.



Impact-safe cross-tunnel construction distributes impact force over the pit's surface area, helping decelerate the vaulter for a safe landing.

AMERICAN BUILT

IAAF, NCAA & NFHS CERTIFIED

13 YEAR WARRANTY

YOUR "ONE-STOP" SOURCE FOR AMERICA'S BASEBALL, SOFTBALL & SPORTS SURFACES & SUPPLIES!

PRICES SUBJECT TO CHANGE & AVAILABILITY PLUS SHIPPING | VOLUME DISCOUNTS AVAILABLE | COOPERATIVE PURCHASING CONTRACT PRICING FOR 50 STATES

Pole Vault Pits



H.S. Pole Vault Value Package

- Includes:
- 1-TP2021 Champion pole vault pit.
- 1-TP2021A all weather cover.
- 1-TPVS6 pair pole vault standards 6' - 18'.
- 1-TFG14-1 14' 10" fiberglass crossbar.
- 1-TPPAD pole vault standard pad.
- 13 YEAR WARRANTY

TVPHPV F Class 250, 1359 lbs

\$20,000

Champion Pole Vault Pit

- 22 oz. Reinforced vinyl "coated both sides".
- 2" Polyurethane spike resistant top pad.
- Heavy duty webbing handles.
- Specially designed foam modules with varying densities.
- Double stitched seams with nylon non-oxidizing zippers.
- Also available in two colors at NO EXTRA CHARGE! [hide]
- 13 YEAR WARRANTY.

TP2021	20' x 21' x 26"; pit and top pad; meets NFHS rules, F Class 250, 953 lbs	\$15,900
TP2021A	All Weather Cover, UPS 84 lbs	\$1,600
TP2021G	Ground Cover, UPS 75 lbs	\$840

High School / Champion Pole Vault Pit

- Made In America by Stackhouse.
- Buy American Quality.
- Sixty Five Years on.
- Thirteen Year Warranty backed by American Sweat, Materials, and Workmanship.
- American made Earth-Cell foam. Exclusive and Trademarked.
- Produced from renewable resources such as Soy.

- Reduces America's dependency on fossil fuels.
- Lessens energy demand for a smaller environmental footprint
- Comfort. Protection. Performance
- Outstanding (Colors won't fade) UV Protection
- Excellent Strength and Wear Longevity
- Comfort Carry Handles.
- Made to Order: Guarantee ship within 3 weeks



YOUR "ONE-STOP" SOURCE FOR AMERICA'S BASEBALL, SOFTBALL & SPORTS SURFACES & SUPPLIES!

PRICES SUBJECT TO CHANGE & AVAILABILITY PLUS SHIPPING | VOLUME DISCOUNTS AVAILABLE | COOPERATIVE PURCHASING CONTRACT PRICING FOR 50 STATES

Cantabrian Pole Vault Pits

Pole Vault Pits

H.S. Pole Vault Value Package by Cantabrian - 32" high
Includes:

- 1-TP2021X Cantabrian H.S. pole vault pit 32" high.
- 1-TP2021XA All Weather Cover.
- 1-TOPVS pair pole vault standards 6' - 18'.
- 1-TFG14-1 14' 10" fiberglass crossbar.
- 1-TPPAD64 pole vault standard pad.
- 13 YEAR WARRANTY

TVPXPV F Class 250, 1513 lbs

\$27,900



USA MADE



Champion Pole Vault Pit - 32" High

- 18 oz. Reinforced vinyl "coated both sides".
- 2" Polyurethane spike resistant top pad.
- Heavy duty webbing handles.
- Specially designed foam modules with varying densities.
- Double stitched seams with nylon non-oxidizing zippers.
- Also available in two colors at NO EXTRA CHARGE! [hide]
- 13 YEAR WARRANTY.

TP2021X 20' x 21' x 32"; pit and top pad; meets NFHS rules, F Class 250, 1107 lbs

\$20,200

TP2021XA All Weather Cover, UPS 84 lbs

\$1,970

TP2021XG Ground Cover, UPS 75 lbs

\$880

High School / Champion Pole Vault Pit

- Made In America by Stackhouse.
- Buy American Quality.
- Sixty Five Years on.
- Thirteen Year Warranty backed by American Sweat, Materials, and Workmanship.
- American made Earth-Cell foam. Exclusive and Trademarked.
- Produced from renewable resources such as Soy.
- Reduces America's dependency on fossil fuels.
- Lessens energy demand for a smaller environmental footprint
- Comfort. Protection. Performance
- Outstanding (Colors won't fade) UV Protection
- Excellent Strength and Wear Longevity
- Comfort Carry Handles.
- Made to Order: Guarantee ship within 3 weeks



YOUR "ONE-STOP" SOURCE FOR AMERICA'S BASEBALL, SOFTBALL & SPORTS SURFACES & SUPPLIES!

PRICES SUBJECT TO CHANGE & AVAILABILITY PLUS SHIPPING | VOLUME DISCOUNTS AVAILABLE | COOPERATIVE PURCHASING CONTRACT PRICING FOR 50 STATES

Pole Vault Pits



Padding required per Rule 7, section 4, article 11 of the NFHS rule book.

All Weather Cover

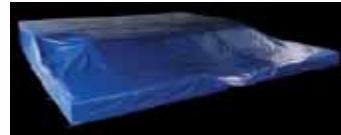

Cantabrian PV Pit 22' x 24' x 28"

- 18 oz. Reinforced vinyl "coated both sides".
- 2" Polyurethane spike resistant top pad.
- Heavy duty webbing handles.
- Specially designed foam modules with varying densities.
- Double stitched seams with nylon non-oxidizing zippers.
- Also available in two colors at NO EXTRA CHARGE! [hide]
- 13 YEAR WARRANTY.

TP2224X	22' x 24' x 28"; pit and top pad; meets IAAF, NCAA & NFHS rules. F Class 250, 1319 lbs	\$19,880
TP2224XA	All Weather Cover, UPS 75 lbs	\$1,900
TP2224XG	Ground Cover, UPS 70 lbs	\$990

International Pole Vault Pit by Cantabrian

- 18 oz. Reinforced vinyl "coated both sides".
- 2" Polyurethane spike resistant top pad.
- Heavy duty webbing handles.
- Specially designed foam modules with varying densities.
- Double stitched seams with nylon non-oxidizing zippers.
- Also available in two colors at NO EXTRA CHARGE! [hide]
- 13 YEAR WARRANTY.

TP2224	22' x 24' x 32"; pit and top pad; meets IAAF, NCAA & NFHS rules. F Class 250, 1519 lbs	\$22,500
TP2224A	All Weather Cover, UPS 84 lbs	\$2,150
TP2224G	Ground Cover, UPS 75 lbs	\$990



Cantabrian Pole Vault Value Package

Includes:

- 1-TP2224X Cantabrian pole vault pit (22' x 24' x 28").
- 1-TP2224XA All Weather Cover.
- 1-TCPVS pair premier Cantabrian pole vault standards 8'6" - 21'.
- 1-TFG14-1 14' 10" fiberglass crossbar.
- 1-TPPAD64 pole vault standard pad.
- 13 YEAR WARRANTY

TVPCPV	F Class 250, 1950 lbs	\$24,200
---------------	-----------------------	-----------------

International Pole Vault Value Package by Cantabrian

Includes:

- 1-TP2224 International pole vault pit (22' x 24' x 32").
- 1-TP2224A All Weather Cover.
- 1-TCPVS pair premier aluminum pole vault standards 9' - 21'.
- 1-TFG14-1 14' 10" fiberglass crossbar.
- 1-TPPAD92 pole vault standard pad.
- 13 YEAR WARRANTY

TVPIPV	F Class 250, 2127 lbs	\$29,800
---------------	-----------------------	-----------------

YOUR "ONE-STOP" SOURCE FOR AMERICA'S BASEBALL, SOFTBALL & SPORTS SURFACES & SUPPLIES!

PRICES SUBJECT TO CHANGE & AVAILABILITY PLUS SHIPPING | VOLUME DISCOUNTS AVAILABLE | COOPERATIVE PURCHASING CONTRACT PRICING FOR 50 STATES

Vault Boxes**Vault Boxes****A. Stainless Steel Vault Box**

Smooth finished stainless box made of 12 gauge stainless steel will not rust, crack or split. The preferred box for universities, colleges & high schools where they are looking for a top quality box that will give years of trouble-free use.

TSSVB UPS 65 lbs. Ships Dimensional **\$790**

Steel Lid

For TSVB & TSSVB.

TSVBL UPS 29 lbs. Ships Dimensional **\$335**

**B. Steel Vault Box**

Heavy gauge steel featuring a curved front lip which eliminates it as a pole obstacle even when the runway is worn down. Has flared sides and 105 degree angle.

TSVB UPS 43 lbs. Ships Dimensional **\$385**

Steel Lid

For TSVB & TSSVB.

TSVBL UPS 29 lbs. Ships Dimensional **\$335**

**C. Welded Aluminum Vault Box**

Thick wall 5052 aluminum welded construction ensures this vault box will last the lifetime of your track. The 1/8" walls and 1/4" bottom and backstop make this the strongest vault box in the industry. Meets all NFHS, NCAA & IAAF Specifications.

TWAVB UPS 24 lbs. Ships Dimensional **\$515**

Aluminum Lid

Aluminum lid is 1/4" thick and uses supports in the middle to ensure lid always has flush appearance. Lid sits flush with top of vault box and may be covered with all-weather track material.

TWAVBL UPS 12 lbs. Ships Dimensional **\$485**

**D. Cast Aluminum Vault Box**

This high quality vault box is designed to give years of trouble-free use. The thick walled aluminum casting will not warp, crack or rust. Inside corners are rounded for easy rotation of pole in box. Ideal for universities, colleges & high schools who are looking for a top of the line vault box that meets all IAAF, NCAA & NFHS specifications.

TCAVB UPS 66 lbs **\$825**

Cast Aluminum Lid

This lid is designed to give attractive level top surface for when TCAVB is not in use. Lid has textured finish to match look of TCAVB but may also have synthetic surface applied to match runway.

TCAVBL UPS 33 lbs. Ships Dimensional **\$410**

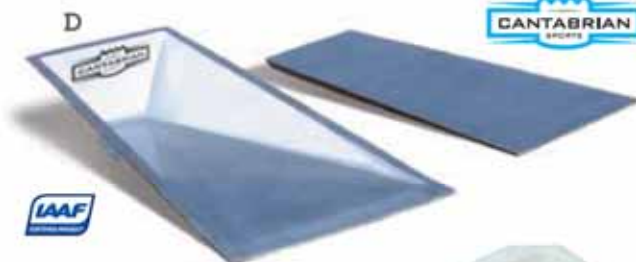
**E. Pole Vault Slide Box**

This lightweight fiberglass slide box is reinforced for years of heavy use. Bright white, it is highly visible and slides straight away. Use indoors or out for fast development of the most crucial part of the vault: the run and plant.

TPVSB UPS 21 lbs. Ships Dimensional **\$490**



YOUR "ONE-STOP" SOURCE FOR AMERICA'S BASEBALL, SOFTBALL & SPORTS SURFACES & SUPPLIES!

PRICES SUBJECT TO CHANGE & AVAILABILITY PLUS SHIPPING | VOLUME DISCOUNTS AVAILABLE | COOPERATIVE PURCHASING CONTRACT PRICING FOR 50 STATES

Value Packs & Pole Accessories

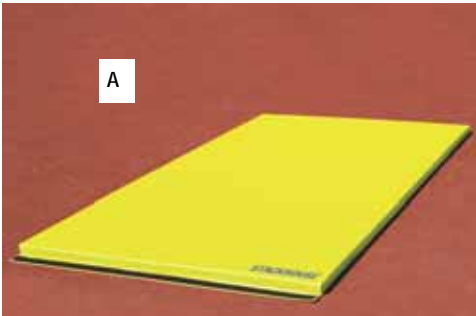

A

A. Vault Protective Padding

This protective padding is designed to be laid on the outside of your pit and cover any or all hard surfaces that are exposed. Made of 2" high-density foam and heavy 18 oz. yellow vinyl, this mat can be attached to another mat with existing velcro flaps on both ends. Comes in 4' x 8' yellow sections.

TVP 4' x 8, Class 70, 20 lbs **\$430**



B

B. Vault Box Collar

Meets ASTM F2949-12 standard and is compliant with NCAA/NFHS 2015 rule. In-ground anchor system limits collar slipping. 3" foam covered with heavy 18oz yellow vinyl.

TVC 33" foam, Class 70, 38 lbs. **\$690**

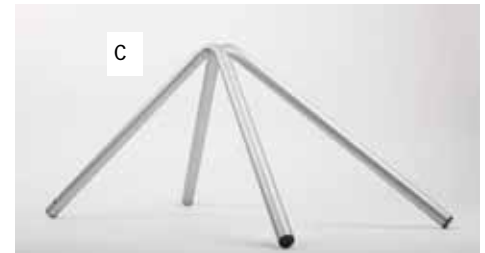

C

C. Weather Cover Insert

This weather cover insert helps keep rain from puddling on pit. 1" coated steel frame with capped ends for protection.

TWCI UPS 5 lbs. **\$50**



D

D. H.S. Boy's Throws Value Pack

Boy's package includes:

- 1-THRD 1.6k rubber discus.
- 1-T51 1.6k blue competition discus.
- 1-T61 1.6k red low spin discus.
- 1-TIS12 12 lb cast iron shot.
- 1-TIWS115 12 lb 115mm turned shot.
- 2-TVCBS vinyl shot & discus carry bag with strap.

TTP-B UPS 41 lbs **\$265**

E. H.S. Girl's Throws Value Pack

Girl's package includes:

- 1-TWRD 1k rubber discus.
- 1-T52 1k blue competition discus.
- 1-T62 1k red low spin discus.
- 1-TIS4 4k cast iron shot,
- 1-TIWS104 4k 104mm turned shot.
- 2-TVCBS vinyl shot & discus carry bag with strap.

TTP-G UPS 30 lb **\$255**



E

IMPLEMENT SELECTION CHARTS			
DISCUS SELECTION CHART		H.S. BOYS	
H.S. GIRLS	RANGE	RIM WEIGHT	RANGE
			RIM WEIGHT
100' to 125'	70% to 73%	100' to 130'	70% to 73%
120' to 150'	73% to 75%	125' to 150'	73% to 75%
140' to 160'	75% to 80%	145' to 160'	75% to 80%
150' to 165'	78% to 85%	155' to 170'	78% to 85%
160' or more	85% to 89%	165' to 180'	85% to 89%
175' to 190'	85% to 90%	190' or more	88% to 91%
DISCUS COMPETITION SPECS:		SHOT COMPETITION SPECS:	
Women, H.S. plus	1 kilo.	Women from H.S. through age 49	4.0 kilo.
H.S. boys	1.6 kilo.	Women age 50 plus	3.0 kilo.
College-masters men to 49	2 kilo.	Boys: H.S.	12 lbs.
Int'l. jr. men (19 & under)	1.75 kilo.	Men to age 49	16 lbs.
Men 50 to 59	1.5 kilo.	Men 50-59	6.0 kilo.
Men 60 plus	1 kilo.	Men 60-69	5.0 kilo.
		Men 70 plus	4.0 kilo.
HAMMER COMPETITION SPECS:			
Women H.S. to 49		4 kilo.	
Women 50 plus		3 kilo.	
H.S. boys		12 lbs.	
College/masters men to age 49		16 lbs.	
Men 50-59		6 kilo.	
Men 60-69		5 kilo.	
Men 70 plus		4 kilo.	

YOUR "ONE-STOP" SOURCE FOR AMERICA'S BASEBALL, SOFTBALL & SPORTS SURFACES & SUPPLIES!

PRICES SUBJECT TO CHANGE & AVAILABILITY PLUS SHIPPING | VOLUME DISCOUNTS AVAILABLE | COOPERATIVE PURCHASING CONTRACT PRICING FOR 50 STATES

Pole Vault Standards

BEST SELLER!

Meets IAAF, NCAA & NFHS Rules.

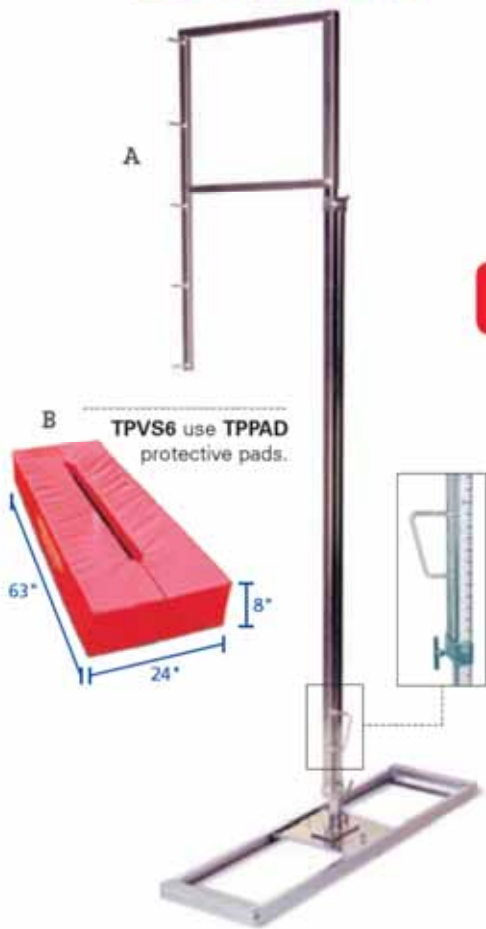

Standard pads are required but sold separately

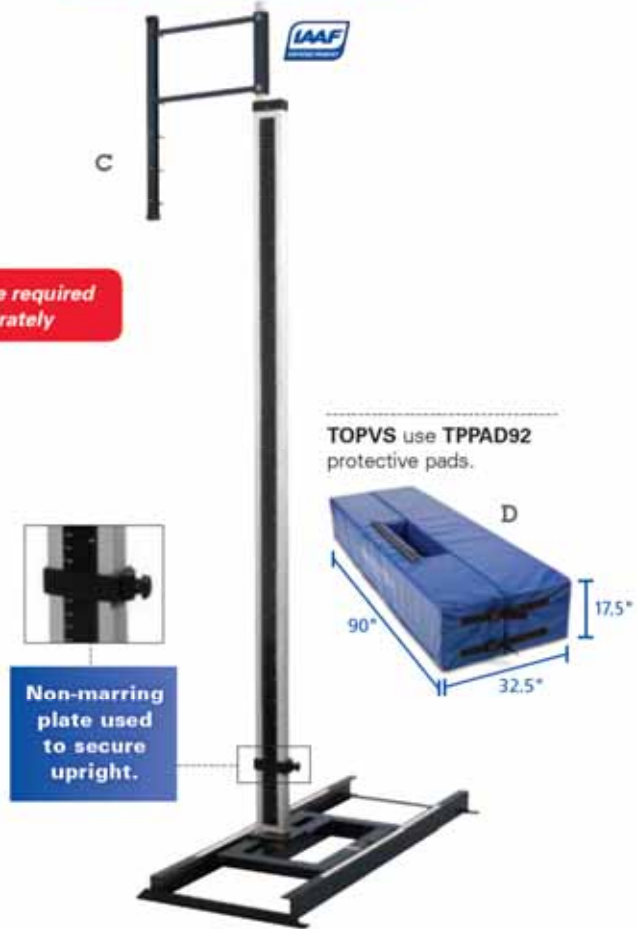

A. Pole Vault Standards

Ideal for beginner to advanced, male & female vaulters because of its height adjustment capability. Adjusts from 6' to 16' on offset riser setting #1. Need additional height? Reset the offset riser for a range of 8' to 18'.

- Adjusts from 6' to 16' & 8' to 18'.
- Easy grip handles for height adjustment and "Spin t-handles" to lock riser in place.
- 60" base with 32" adjustability behind the box.
- Chrome plated rust resistant steel risers.

TPVS6 Pair; 6' - 18' F Class 60, 198 lbs **\$1,665**

B. Pole Vault Standard Pad

Fits Stackhouse TPVS6 standards. Snug fitting pad gives excellent protection at a budget price. 17" x 62" inside dimension fits most bases.

TPPAD Pair; 17" x 62" inside **\$1,070**
UPS 40 lbs each, Ships Dimensional

Pole Vault Standards—Universal 3' Extension
Allows lowering crossbar additional 3'. For beginning vaulters. Fits all crossbar standards.

TPVSEU Pair; 3' UPS 10 lbs. **\$220**

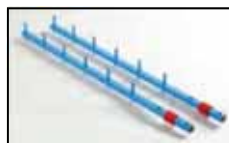

C. Premier Aluminum Pole Vault Standards

Stackhouse's top of the line lightweight standard, with aluminum uprights and steel base for stability. • Meets IAAF, NCAA and NFHS Rules.

- 2.5" D x 5.5" W aluminum uprights with telescoping riser.
- 72" L x 24" W steel base with leveling devices on four corners and anchoring points.
- Adjusts from 9' to 21'; marked in both Standard and Metric measurement.
- Offset risers have easy 6" height adjustment increments. Includes 75mm and 55mm crossbar rest pegs for NCAA & IAAF events.
- Uprights mounted on offset steel carriage that rides on poly wheels. Adjusts from 0 - 32"/ 80 cm.

TOPVS Pair; 9' - 21' F Class 60, 4 pkgs 385 lbs **\$2,670**

D. Offset Base Protector Pad

Fits Stackhouse TOPVS. Works on all offset riser standards. Made of high density foam with 18 oz. polyester vinyl coated on both sides. Adjustment measurement scale on top of pad.

TPFPAD92 Pair; 90"l x 32 1/2"w x 17 1/2"h **\$1,475**
F Class 100, 95 lbs

Pole Vault Standards - Premier 3' Extensions

Fits TOPVS standards and similar models and styles. Call for details.

TPVSEO Pair; 3' UPS 10 lbs **\$180**

YOUR "ONE-STOP" SOURCE FOR AMERICA'S BASEBALL, SOFTBALL & SPORTS SURFACES & SUPPLIES!

PRICES SUBJECT TO CHANGE & AVAILABILITY PLUS SHIPPING | VOLUME DISCOUNTS AVAILABLE | COOPERATIVE PURCHASING CONTRACT PRICING FOR 50 STATES

Pole Vault Standards



E. Cantabrian Pole Vault Standards

New International/Collegiate design standards.

- Meets IAAF, NCAA & NFHS Rules.
- All aluminum construction. Uses 4" diameter extrusion for upright with telescoping aluminum riser.
- Standards adjust from 8' 6" to 21' (Standard & Metric) with easy turn locking knob that use "Reader Finger" for easy reading of height adjustment.
- Offset riser is made of aluminum with easy view "Optic Yellow" finish. Offset riser attaches to upright riser with through bolts and use nylock nuts to insure firm attachment. Crossbar pens every 6" for quick height adjustment.
- Base is all aluminum channel, marked for location of carriage. Threaded orange stop bumper can be adjusted to insure carriage does not go past zero.

TCPVS Pair; 8'6" - 21' F Class 60, 4 Pkgs 305 lbs **\$3,380**

F. Cantabrian Standard Pad

For High School Pole Vault Pits.

TPPAD64 UPS 45 LBS each, Ships Dimensional **\$1,275**

G. Cantabrian International Crossbars

High quality pulltruded fiberglass bar. Special optic colors give jumper easy height visualization. Meets all NFHS, NCAA & IAAF specifications.

TCFHJ13 13' 1 1/2" High Jump Crossbar 6lbs, frt class 70 **\$149**

TCPV14 14' 10" Pole Vault Crossbar F 6lbs, frt class 70 **\$165**

Replacement Crossbar End (not shown)

TCEND International/College UPS 2 lbs **\$17**

YOUR "ONE-STOP" SOURCE FOR AMERICA'S BASEBALL, SOFTBALL & SPORTS SURFACES & SUPPLIES!

PRICES SUBJECT TO CHANGE & AVAILABILITY PLUS SHIPPING | VOLUME DISCOUNTS AVAILABLE | COOPERATIVE PURCHASING CONTRACT PRICING FOR 50 STATES

Shot Put Throwing Sector Surfaces**SHOT PUT THROWING**
SECTOR SURFACES

Shot Put Throwing Sector Surfaces make a firm, smooth surface with great drainage. Available in burgundy red, grey, black, white or tan with either 20% red, grey, black, white or tan **Beam Clay® Binder** for a smoother surface, or 5% red, grey, black, white or tan **Beam Clay® Binder** for a somewhat "crunchier" surface, or "**STABILIZED**" in red, grey, black, white or tan for a firmer, yet more resilient, surface – each with excellent drainage and resistance to erosion. Recommended depth is 3"-4" over a firm, well-draining base.

**3/16" Shot Put Throwing Sector Surfacing with Natural Beam Clay® Binder**

One cubic yard weighs approximately 2,700 lbs. in red, approximately 3,240 lbs. in grey, black, white or tan, plus add 20% for compaction. Each 1" compacted requires approximately 5 tons per 1,000 square feet in red or 6 tons per 1,000 square feet in grey, black, white or tan.

		BULK/TON		50 LB. BAG Up to 50/pallet
Burgundy Red with 5% Beam Clay® Red Binder	SP-R5 BULK	\$79	SP-R5 BAG	\$9
Burgundy Red with 20% Beam Clay® Red Binder	SP-R20 BULK	\$109	SP-R20-BAG	\$10
Grey with 5% Beam Clay® Grey Binder	SP-G5-BULK	\$69	SP-G5 BAG	\$8.75
Grey with 20% Beam Clay® Grey Binder	SP-G20-BULK	\$99	SP-G20 BAG	\$9.50
Black or White with 5% Beam Clay® Black or White Binder	SP-(B, W)5-BULK	\$79	SP-(B, W)5 BAG	\$9.00
Black or White with 20% Beam Clay® Black or White Binder	SP-(B, W)20-BULK	\$109	SP-(B, W)20 BAG	\$10
Tan with 5% Beam Clay® Tan Binder	SP-T5 BULK	\$145	SP-T5 BAG	\$12
Tan with 20% Beam Clay® Tan Binder	SP-T20 BULK	\$175	SP-T20 BAG	\$13

3/16" Shot Put Throwing Sector Surfacing with Stabilizer® Binder

For an even firmer yet more resilient surface with even less maintenance. One cubic yard weighs approximately 2,700 lbs. in red, approximately 3,240 lbs. in grey, black, white or tan plus add 20% for compaction. Each 1" compacted requires approximately 5 tons per 1,000 square feet in red or 6 tons per 1,000 square feet in grey, black, white or tan.

		BULK/TON		50 LB. BAG Up to 50/pallet
Burgundy Red with Stabilizer® Binder	SP-RS BULK	\$135	SP-RS BAG	\$11.25
Grey with Stabilizer® Binder	SP-GS BULK	\$125	SP-GS BAG	\$11
Black or White with Stabilizer® Binder	SP-(B,W)S BULK	\$135	SP-(B,W)S BAG	\$11.25
Tan with Stabilizer® Binder	SP-TS BULK	\$205	SP-TS BAG	\$13.50

PALLET & COVER CHARGES: \$10.50/PALLET.

Also available:

Regional Shot Put Throwing Sector Surfacing from plants in the South, Mid-West, and West Coast.

YOUR "ONE-STOP" SOURCE FOR AMERICA'S BASEBALL, SOFTBALL & SPORTS SURFACES & SUPPLIES!

PRICES SUBJECT TO CHANGE & AVAILABILITY PLUS SHIPPING | VOLUME DISCOUNTS AVAILABLE | COOPERATIVE PURCHASING CONTRACT PRICING FOR 50 STATES

Shots / Throwing Weights

Competition Iron Shot Puts

These iron shots are official weight and size, and are ideal for competition and practice. We offer all standard weights. Masters, Special Olympics, and overweight training shots.



TIS3	3 lbs.; Special Olympics; 71mm UPS 4 lbs.	\$23
TIS45	4 lbs.; Special Olympics; 80mm UPS 5 lbs.	\$27
TIS2	2 kilo; 88mm UPS 6 lbs.	\$26
TIS6	6 lbs.; 91mm UPS 7 lbs.	\$24
TIS3M	3 kilo women; 50+ 93mm UPS 8 lbs.	\$26
TIS8	8 lbs.; 99mm UPS 9 lbs.	\$28
TIS4	4 kilo; 104mm (orange) UPS 10 lbs.	\$32
TIS10	10 lbs.; 107mm UPS 10 lbs.	\$35
TIS5M	5 kilo men; 60+ 112mm UPS 13 lbs.	\$37
TIS12	12 lbs.; 114mm UPS 13 lbs.	\$37
TIS6M	6 kilo men; 50-59 119mm UPS 14 lbs.	\$45
TIS14	14 lbs.; 121mm UPS 15 lbs.	\$53
TIS16	16 lbs.; 126mm UPS 17 lbs.	\$53

World Class Shots

These iron shots have been lathe turned to size and are perfectly round. Designed for advanced throwers, these shots give championship performance at a budget price. (Colors may vary)



TIWS100	4 kilo; 100mm UPS 10 lbs.	\$78
TIWS104	4 kilo; 104mm UPS 10 lbs.	\$64
TIWS108	4 kilo; 108mm UPS 10 lbs.	\$68
TIWS112	12 lbs; 108mm UPS 13 lbs.	\$92
TIWS115	12 lbs.; 115mm UPS 13 lbs.	\$72
TIWS120	16 lbs.; 120mm UPS 17 lbs.	\$116
TIWS125	16 lbs.; 125mm UPS 17 lbs.	\$102
TIWS128	16 lbs.; 128mm UPS 17 lbs.	\$89

Turned Steel Shot

The turned steel shots are for the more advanced thrower looking for a specific diameter shot for competition. These shots have been lathe turned and are balanced for the best performance. (Colors may vary)



TSS96	4 kilo; 96mm UPS 10 lbs.	\$115
TSS109	4 kilo; 109mm UPS 10 lbs.	\$119
TSS102	12 lbs.; 102mm UPS 13 lbs.	\$115
TSS110	12 lbs.; 110mm UPS 13 lbs.	\$119
TSS117	12 lbs.; 117mm UPS 13 lbs.	\$129
TSS116	16 lbs.; 110mm UPS 17 lbs.	\$119
TSS129	16 lbs.; 129mm UPS 17 lbs.	\$130

Stainless Steel Shots

High quality stainless steel shots are lathe turned to a perfect sphere and are designed for world class competition.



TSP4	4 kilo; 95mm UPS 10 lbs.	\$153
TSP12	12 lbs.; 103mm UPS 13 lbs.	\$180
TSP16	16 lbs.; 110mm UPS 17 lbs.	\$197

Brass Shot Put

Lathe turned to minimum diameter allowed in competition. Machined finish gives excellent grip. Calibrated to exact weight. Quality of this shot is unsurpassed.



TB4	8 lbs. 13 oz. (4 kilo); 95mm UPS 10 lbs.	\$158
TB12	12 lbs. (5.44 kilo); 102mm UPS 13 lbs.	\$191
TB16	16 lbs. (7.25 kilo); 110mm UPS 17 lbs.	\$208

Cantabrian Steel Shots

These shots are the maximum legal diameter. Perfectly balanced for optimum flight. This shot only offered in one diameter per size. True competition shot with a lightly textured finish.

TCS129	16 lbs.; 129mm UPS 16 lbs.	\$130
TCS117	12 lbs.; 117mm UPS 12 lbs.	\$129
TCS109	4 kilo; 109mm UPS 10 lbs.	\$115



Indoor Shots - Soft Shell

These accurate weight, soft shell shots are ideal for indoor meets and practice. They will not mar floor, yet retain round shape.



TSS6	6 lbs.; 100mm UPS 7 lbs.	\$75
TSS8	8 lbs.; 113mm UPS 9 lbs.	\$85
TSS4	4 kilo; 114mm UPS 10 lbs.	\$85
TSS12	12 lbs.; 126mm UPS 13 lbs.	\$95
TSS16	16 lbs.; 138mm UPS 17 lbs.	\$125

Indoor Shots - Hard Shell

These accurate weight, hard shell shots hold their round shape and are designed to be thrown onto indoor track surfaces or dirt. They are NOT recommended for wood floors.



THS6	6 lbs.; 100mm UPS 7 lbs.	\$80
THS8	8 lbs.; 113mm UPS 9 lbs.	\$87
THS4	4 kilo; 114mm UPS 10 lbs.	\$90
THS12	12 lbs.; 125mm UPS 13 lbs.	\$105
THS16	16 lbs.; 137mm UPS 17 lbs.	\$135

SHOT COLORS MAY VARY.
REFER TO PAGE 38 FOR SHOT SELECTION GUIDE.

YOUR "ONE-STOP" SOURCE FOR AMERICA'S BASEBALL, SOFTBALL & SPORTS SURFACES & SUPPLIES!

PRICES SUBJECT TO CHANGE & AVAILABILITY PLUS SHIPPING | VOLUME DISCOUNTS AVAILABLE | COOPERATIVE PURCHASING CONTRACT PRICING FOR 50 STATES

Hammers

Hammers



All hammer handles conform to new IAAF rules.

Cantabrian Hammer

Minimum diameter steel hammers have perfect balance. Light textured powder coat finish. Stainless steel swivel. High quality stainless steel bearings. Comes with wire and handle.

TCSH110	110 16 lbs.; 110mm; Black UPS 17 lbs.	\$177
TCSH103	12 lbs.; 102mm; Blue UPS 13 lbs.	\$165
TCSH95	4 K; 95mm; Pink UPS 10 lbs.	\$145



Cantabrian Aluminum Hammer Handle

Machine cut from solid forged aluminum ingot helps to ensure handle never elongates or stretches. CNC cut to make for perfect fit in throwers hand. Precise 110mm measurement from bottom of handle to center of hammer wire hole ensures consistent hammer lengths and throws. Pressed bronze bushing where wire is attached is radiused for easy swivel of wire during wind up and throws. Was used on hammer that set new record for hammer throw.



TCAHH	UPS 3 lbs.	\$69
--------------	------------	------

A. Stainless Steel Hammer

Stainless steel hammer uses a high quality stainless high spin swivel and comes with 2mm wire and Olympic handle.

THSS4	4 kilo; 95mm UPS 10 lbs.	\$239
THSS12	12 lbs.; 103mm UPS 13 lbs.	\$275
THSS16	16 lbs.; 110mm UPS 17 lbs.	\$309

B. Lathe-Turned Iron Hammer

Meets all official specifications. All steel swivel, wire and competition steel handle included.

TIH4	4 kilo; 101mm UPS 10 lbs.	\$83
TIH5.5	5.5 kilo (12 lbs); 112mm UPS 13 lbs.	\$92
TIH7	16 lbs.; 124mm UPS 17 lbs.	\$99



Hammer Wires

Meets all official specifications. All steel swivel, wire and competition steel handle included.

TW1	37.5" UPS 2 lbs. each	\$16
TW2	38" UPS 2 lbs. each	\$16
TW3	38.25" UPS 2 lbs. each	\$16
TW4	38.5" UPS 2 lbs. each	\$16
TW5	39" UPS 2 lbs. each	\$16
TW5.5	39.5" UPS 2 lbs. each	\$16

Gloves-Hammer

World-famous high quality glove. Has extra wide leather piece over fingers for longer wear and safety.

TGLM	Left; medium UPS 2 lbs. each	\$40
TGLL	Left; large UPS 2 lbs. each	\$40
TGLXL	Left; x-large UPS 2 lbs. each	\$40
TGRM	Right; medium UPS 2 lbs. each	\$40
TGRL	Right; large UPS 2 lbs. each	\$40
TGRXL	Right; xlarge UPS 2 lbs. each	\$40



Distance Markers

Used for marking contestant's throws. Competitors' names and numbers can be written on marker with chalk. Durable and long-lasting.

TDM	Dozen UPS 3 lbs.	\$40
------------	------------------	------



Removable discus tray.

REFER TO PAGE 39 FOR HAMMER SELECTION GUIDE

Multi-Use Implement Cart

The heavy duty, all steel cart will hold 8 shots, 8 discus and 8 javelins at one time. Discus tray can be lifted out of the cart and set in discus area, works great for storage and competition. Cart rides on 4 solid wheels.

TMIC	101 lbs. F Class 70	\$749
-------------	---------------------	-------



D. Shot & Discus Carry Bag

TCCB	Canvas UPS 2 lbs.	\$35
TVCB	Vinyl UPS 2 lbs.	\$19
TVCBS	Vinyl with Strap UPS 2 lbs.	\$21



E. Shot Carrier

Designed to carry one shot, hand tied from heavy polyethylene rope and has comfort carry handles.

TSPC	UPS 2 lbs.	\$14
-------------	------------	------

YOUR "ONE-STOP" SOURCE FOR AMERICA'S BASEBALL, SOFTBALL & SPORTS SURFACES & SUPPLIES!

PRICES SUBJECT TO CHANGE & AVAILABILITY PLUS SHIPPING | VOLUME DISCOUNTS AVAILABLE | COOPERATIVE PURCHASING CONTRACT PRICING FOR 50 STATES

Stands & Miscellaneous Accessories

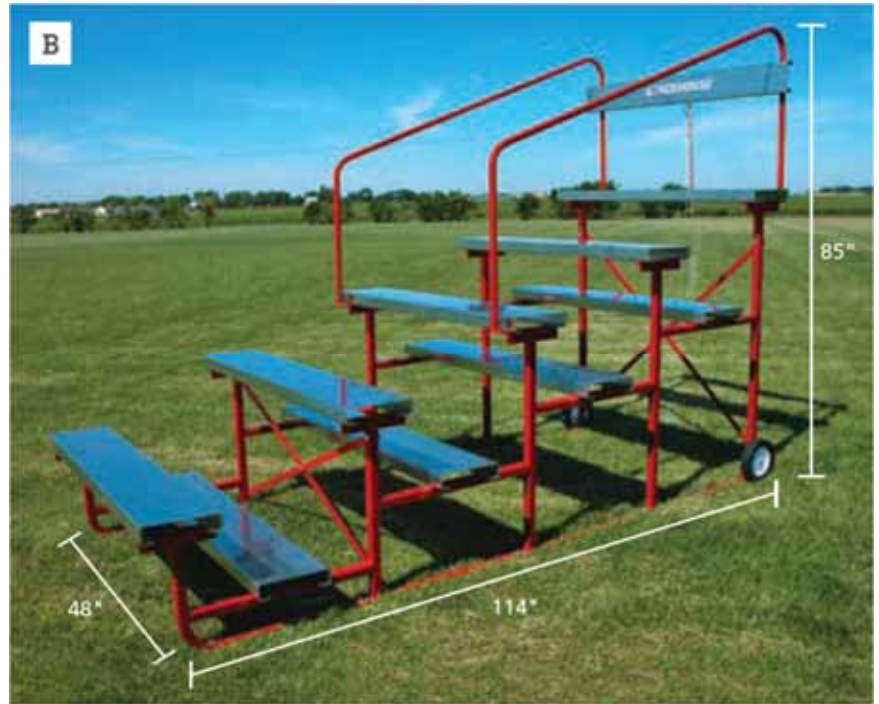

A. Track Starters Stand

This all steel powder coated two-step stand will give your starter the visibility they need. Two solid wheels make this stand easy to transport.

TSSTAND F Class 250, 73 lbs **\$675**

B. Track Judges Stand

- Movable stand with 8" wheels accommodates 10 judges.
- Rail support for safety.
- Red enamel finish.
- Galvanized steel seats, footrests and back support.

TTJS F Class 250, 230 lbs **\$1,385**

C. Track Equipment Wagon

The perfect vehicle for hauling a variety of equipment from the storage area to the track. Fold down gates, 13" pneumatic tires, 1000 lbs. capacity. Color of cart may vary. Equipment not included.

TSEW 45" L x 26" H x 23" W UPS 80 lbs. **\$285**



D. Pit Rake

Excellent heavy duty aluminum rake for raking and smoothing landing pits and baseball infields. One side has long, sturdy teeth and the other side has flat edge for leveling.

TGR24 24" pit rake UPS 5 lbs. Ships Dimensional **\$73**

TGR 36" infield rake UPS 6 lbs. Ships Dimensional **\$85**

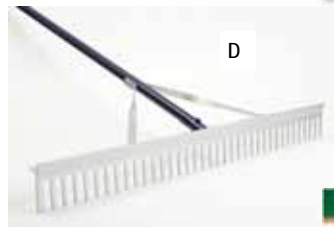

F. Plastic Flag Ropes

Colorful pennants ideal for cross-country chutes and roping off restricted areas for crowd control. 100 ft. in length. Stock color is red, white and blue. .

FPFR Custom colors available; additional \$10fee applies. UPS 2 lbs **\$34**

G. Boundary Cones

Heavy duty cones have weighted bases and have hundreds of uses for drills, cross country courses, gym activities, or establishing temporary zones.

FBC12 12" heavy cones UPS 2 lbs. **\$18**

FBC18 18" heavy cones UPS 4 lbs. **\$20**



YOUR "ONE-STOP" SOURCE FOR AMERICA'S BASEBALL, SOFTBALL & SPORTS SURFACES & SUPPLIES!

PRICES SUBJECT TO CHANGE & AVAILABILITY PLUS SHIPPING | VOLUME DISCOUNTS AVAILABLE | COOPERATIVE PURCHASING CONTRACT PRICING FOR 50 STATES

A. Lap Counter with Bell

This lap counter is made with an aluminum frame and plated steel base. Wheels on base make for easy transportation. Swivel top allows numbers to be rotated around for full viewing. Unit comes with 2-10" flip indicators. Each indicator contains 10 numbers from 0-9. Indicators have side flip lever for quick easy number changes. Comes with loud brass bell to indicate last lap.

TLC UPS 3 pkgs (1) at 11 lbs., (1) at 17 lbs., (1) at 3 lbs. + AH **\$485**

B. Performance Indicators

This performance indicator is made with an aluminum frame and plated steel base. Wheels on base make for easy transportation. Swivel top allows numbers to be rotated around for full viewing. Unit comes with 4 or 5-10" flip indicators. Each indicator contains 10 numbers from 0-9. Indicators have side flip lever for quick easy number changes.

TEPI-4 4 digit event performance indicator **\$600**
UPS 3 pkgs (1) at 21 lbs., (1) at 26 lbs., (1) at 5 lbs. + AH

TEPI-5 5 digit event performance indicator **\$625**
UPS 3 pkgs (1) at 24 lbs., (1) at 26 lbs., (1) at 5 lbs. + AH

C. Replacement Digital Numbers

Can be used for both the "TLC" lap counter and "TEPI" indicators as replacement numbers. Will also fit similar units using same sizes. (13 1/4" x 7 1/2" x 1 1/16").

TDI Black UPS 3 lbs. **\$110**

TDIR Red UPS 3 lbs. **\$110**

D. Wind Gauge

Has following features: Current maximum wind speed. Average wind speed over 5, 10, or 13 seconds. Choose from any measurement unit. Reads in tenths. Current temperature and wind chill. Replaceable 400 hour lithium battery. Data lock feature. Replaceable plastic impeller will not corrode. Comes with lanyard. Threaded for tripod mounting. Adjustable tripod. Accuracy is +/- 1%, when aligned with wind's axis.

TWG UPS 7 lbs. **\$470**

E. Track & Field Score Book

Scores 19 meets. Up to 8 places can be scored. Time, height, or distance can be recorded for all places. Can be used for duals of up to five teams. Room to score 14 individual events and 3 relays. Illustrated sample score sheet.

TSB UPS 1 lb. **\$15**

F. Digital Implement Scale

This scale is perfect for use at meets where you want an accurate scale that will weigh up to the largest implements. Scale is accurate to 0.1 ounce and has a 55 lb. capacity. Easy read digital scale is powered by 4 "C" cell batteries (not included). Also includes an AC Adapter. Detachable faceplate, too many functions to list.

TDIS UPS 9 lbs. **\$140**

G. Ultrak Scoreboard/Display

Radio frequency remote control scoreboard, controllable and viewable from 150 feet away. 4" LCD digits. 20" wide by 30" high. Runs on four D cell batteries (not included) - no cords required. Programmable count-up/down game time with range to 9 hrs., 59 min., 59 sec. Four inch LCD digits display scores for two teams up to 199. Competitor and attempt numbers can be changed to home and guest numbers for court event scoreboard. Free standing on floor; table or wall-mounted.

TSWScore UPS 22 lbs. Ships Dimensional **\$935**

H. Ultrak T-100 Display/Race Clock

Radio frequency remote control display timer is controllable and viewable from 150 feet away. 4" LCD digits. 20" wide by 12" high. Runs on four D cell batteries (not included) - no cords required. Timer is programmable for count-up/down game or event time with range to 9 hrs., 59 min., 59 sec. with four-inch LCD digits. Free standing on floor; table or wall-mounted.

TSWT100 UPS 10 lbs. **\$705**



YOUR "ONE-STOP" SOURCE FOR AMERICA'S BASEBALL, SOFTBALL & SPORTS SURFACES & SUPPLIES!

PRICES SUBJECT TO CHANGE & AVAILABILITY PLUS SHIPPING | VOLUME DISCOUNTS AVAILABLE | COOPERATIVE PURCHASING CONTRACT PRICING FOR 50 STATES

Discus Cage & Rings



*Freight offer valid in lower 48 U.S. states only.

Cantabrian Aluminum Discus Cage

- Sets up in less than 15 minutes.
- Premium quality cantilevered 2 7/8" aluminum poles. 16' height.
- 2' sleeve.
- 14' net height.
- Angled poles for added safety.
- Heavy duty 14' x 58' UV 3mm weather resistant net.
- Easily raised and lowered.
- Product comes with spectator warning signs.
- Exceeds NFHS specifications.
- Stackhouse Discus Cage conforms to the 34.92" throwing sector rule.

Sector Line Tape With Reel

- 3" wide, double-coated vinyl material
- 330' in length
- Plastic reel included for easy use and storage

SLT

\$385



High School Aluminum Discus cage

THCSA-14 F Class 70, 6pcs, 285lbs \$2,975

Replacement net for THCSA-14

THCSA14x58 UPS 31lbs. Ships Dimensional \$1,460

Replacement sleeve only for THCSA-14

THCSASL UPS 1lbs ea \$58

13' 4" height with (6) square steel, white powder coated poles

THSCAN14 F Class 70, 350 lbs, Call for Freight Quote \$3,010

Replacement net for THSCAN14 (14' x 55')

TDC14X55RPL UPS 31 lbs. Ships Dimensional \$915

Replacement sleeve only for THSCAN14 (1 ea.)

THSCAN14SL UPS 13 lbs. \$54

A. Webbed Discus Ring

This discus ring is manufactured in two half circles and uses 1/4" x 3" strip with welded cross braces for added rigidity and ease of installation. Two half circles are bolted together before installation ensuring circle stays round.

TCDWEB F Class 70, 85 lb \$845

Webbed Shot/Hammer Ring

This shot/hammer ring is manufactured in two half circles and uses a 1/4" x 3" strip with welded cross braces for added rigidity and ease of installation. Two half circles are bolted together before installation ensuring circle stays round.

TCSHWEB F Class 70, 67 lbs \$820

B. Official Circles

Aluminum angle constructed ring. Made of 1" x 3/4" x 1/4" aluminum. Comes in 4 sections with anchoring holes.

TADR 4 pc. discus ring UPS 10 lbs. Ships Dimensional \$245

TASR 4 pc. shot ring UPS 10 lbs. Ships Dimensional \$245

2-piece design that hinges in center for economical UPS shipping. Made of 1/4" x 1 1/2" steel. Can be screwed or bolted down.

T2PCD 2 pc. discus ring UPS 36 lbs. Ships Dimensional \$310

T2PCS 2 pc. shot ring UPS 28 lbs. Ships Dimensional \$275

C. Sector Guide

This sector guide allows you to correctly lay out your throwing zone in a matter of minutes. Comes with an all-weather vinyl template and instructions. Template marked for shot, discus, javelin and hammer.

TSG UPS 6 lbs \$109

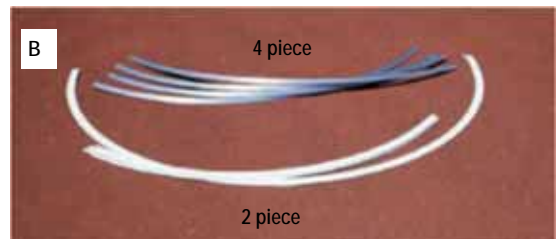

D. Sector Line Marking Tape

Line your throwing area in minutes with this easy to see sector tape. Comes in 2" x130 yd. rolls.

TSTW White UPS 6 lbs. \$52

TSTO Orange UPS 6 lbs. \$52

TSTS Spool for sector tape UPS 5 lbs. \$28

TGS Ground staples for tape. Pack of 10 UPS 3 lbs. (on average, one every 10') \$18

YOUR "ONE-STOP" SOURCE FOR AMERICA'S BASEBALL, SOFTBALL & SPORTS SURFACES & SUPPLIES!

PRICES SUBJECT TO CHANGE & AVAILABILITY PLUS SHIPPING | VOLUME DISCOUNTS AVAILABLE | COOPERATIVE PURCHASING CONTRACT PRICING FOR 50 STATES

Portable Discus Cage



Completely welded base support (no caps) with internal weight stability.

Reinforced support bracing keeps the portable frame rigid under normal use.



Premier Outdoor Throwing Platform

Portable Discus Cage #HSDC-P / #CDC-P

When your throwers need to relocate from time to time, this portable discus cage puts safety on the move. Precisely angled brackets, combined with exact length weighted support braces, allow for a repeatable cage assembly adds stability and eliminates human error.

- All-aluminum posts (4"OD) feature 3' offset to prevent implement deflection - 14'H for HS/17'H for NCAA
- Weather-treated nylon main safety net (14'H for HS/17'H for NCAA) can be set up and taken down with a simple pulley system
- Offset eye-bolts secure bottom of net to base
- Included backup net (7') keeps onlookers at a safer distance from main safety net
- Meet all NFHS/NCAA rules and regulations
- See drawings for specifications, installation instructions and plan/layout recommendations
- Proudly Made in the USA

Premier Outdoor Throwing Platform #POP

This is a versatile outdoor platform designed to be used in conjunction with our Portable Discus Cage.

- Versatile outdoor platform designed to be used in conjunction with our Portable Discus Cage
- Nominal Size 9'W x 9'L x 3"H
- Two identical panels, with recessed handles for lifting, bolt together during use via an internal mate, which allows for a seamless alignment and tight fit
- Each panel features a three-layer construction: a structural aluminum inner core; a 3/4" thick grade A plywood surface (chamfered at the seam); and a synthetic rubber top to allow for minimal friction
- Retractable stainless steel handles are ergonomically designed to allow for quick and easy moving of platform
- Add our Model No. HDR-S Conversion Ring and Model No. STBC Toe Board and your ready for the Shot Event
- Proudly Made in the USA

Vinyl Sandbags

- Fabricated with 18 oz. vinyl panels measuring 18" x 18" with heavy gauge zipper
- Heavy duty canvas handles attached via Box-X stitch method
- Yellow is standard - also available in white

#VSZ Vinyl Sandbags \$90

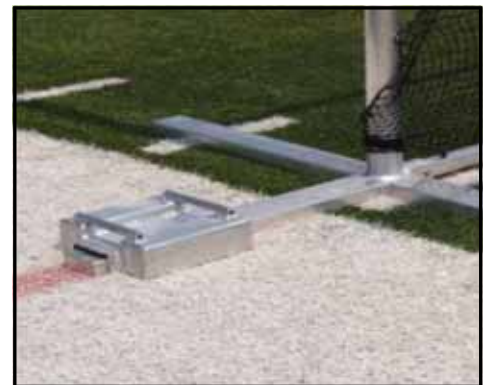

Base Weights (80 lbs.)

- Adds further stability to portable products in a more seamless fashion
- Aluminum construction guarantees no rusting
- Optional 3" or 5" wide welded channel to fit

#BW-80 Base Weights \$625

#HSDC-P	High School Portable Discus Cage	\$16,450
#CDC-P	Collegiate Portable Discus Cage	\$22,535
#POP	Premier Outdoor Throwing Platform	\$10,145

YOUR "ONE-STOP" SOURCE FOR AMERICA'S BASEBALL, SOFTBALL & SPORTS SURFACES & SUPPLIES!

PRICES SUBJECT TO CHANGE & AVAILABILITY PLUS SHIPPING | VOLUME DISCOUNTS AVAILABLE | COOPERATIVE PURCHASING CONTRACT PRICING FOR 50 STATES